

iCombi[®] Classic

Operating instructions



1	Introduction.....	6
1.1	Product warranty.....	6
1.2	Target group.....	6
1.3	Intended use.....	6
1.4	Working with this manual.....	6
1.4.1	Explanation of symbols.....	6
1.4.2	Explanation of pictograms.....	6
1.4.3	Explanation of safety messages.....	7
1.4.4	Images.....	7
1.4.5	Technical changes.....	7
2	General safety instructions.....	8
2.1	Safety instructions for units with a gas connection.....	9
2.2	Personal protective equipment.....	10
3	The iCombi Classic.....	11
4	How to work with the unit.....	12
4.1	Initial start-up.....	12
4.2	Switching the unit on and off.....	12
4.3	Interacting with the unit.....	12
4.4	Maximum load sizes.....	13
4.5	Opening and closing the cooking cabinet door.....	13
4.6	Loading the unit.....	13
4.6.1	Loading the unit with the mobile oven rack or the mobile plate rack.....	14
4.6.2	Loading the Combi-Duo with the mobile oven rack or the mobile plate rack.....	15
4.7	Inserting core temperature probe.....	17
4.8	Using the hand shower.....	19
4.9	Removing hinging rack.....	21
4.10	Integrated fat drain.....	21
5	Preparing food.....	23
5.1	Open modes.....	23
5.2	Cooking parameters.....	23
5.3	Additional functions.....	25
5.4	Steam.....	26
5.4.1	Cooking climate and temperature range.....	26
5.4.2	Cooking food in steam.....	26
5.5	Combination of steam and hot air.....	27
5.5.1	Cooking climate and temperature range.....	27
5.5.2	Cooking the food in the combination of steam and hot air.....	27
5.6	Convection.....	28
5.6.1	Cooking climate and temperature range.....	28
5.6.2	Cooking food in convection heat.....	28
6	Sous-vide cooking.....	30

7	Finishing	31
7.1	Cooking climate and temperature	31
7.2	Finishing food	31
8	Programming mode	33
8.1	Start programming mode	33
8.2	Pre-defined programme	33
8.3	Create new programme	34
8.4	Start programme	36
8.5	Edit programme	36
8.6	Delete programme	37
8.7	Sort programme list	37
8.8	Upload and download programmes	38
9	Settings	39
9.1	Open settings	39
9.2	Set the temperature unit	39
9.3	Set date and time	40
9.4	Switch keyboard	41
10	Kitchen management	42
10.1	Hygiene management	42
10.1.1	Logged HACCP data	42
10.1.2	Download HACCP data	42
10.2	Connected units to a network	43
10.3	ConnectedCooking (optional)	43
11	Automatic cleaning	44
11.1	General safety instructions	44
11.2	Cleaning programmes	44
11.3	Start automatic clean	45
11.4	Abort automatic clean	46
12	Care	47
12.1	General safety instructions	47
12.2	Care intervals	47
12.3	Care products	47
12.4	Cleaning cooking cabinet door	48
12.5	Cleaning the hand shower	49
12.6	Cleaning the drip tray and drain channel	49
12.7	Cleaning the air filter	49
12.8	Cleaning accessories	49
13	Inspiration and help	50
13.1	Telephone help	50
13.2	Retrieving unit data	50
13.3	Problem resolution	50
13.3.1	Error messages heating steam generator	51
13.3.2	Error messages for gas units	51

13.3.3	Error messages heating hot air.....	52
13.3.4	Error messages moisture.....	52
13.3.5	Error messages CleanJet.....	53
13.3.6	Error messages Care.....	53
13.3.7	Notification centre.....	53
13.3.8	Error messages when operating the UltraVent.....	54
14	Maintenance.....	55
14.1	Replacing air filter.....	55
14.2	Replacing the cooking cabinet door gasket.....	56
15	Transport.....	57
15.1	Empty steam generator.....	57
15.2	Transport unit.....	57
16	Decommissioning and disposal.....	59
16.1	Decommissioning.....	59
16.2	Disposal.....	59
17	Technical data.....	60
17.1	Units with an electrical connection.....	60
17.2	Units with a gas connection.....	60
17.3	Models and version names.....	60
17.4	Conformity.....	60
17.4.1	Units with an electrical connection.....	60
17.4.2	Units with a gas connection.....	61
18	Regulatory Information.....	62
	63

1 Introduction

Dear customer,

Congratulations on purchasing your new iCombi Classic. Read the operating instructions carefully prior to using your unit for the first time. The operating instructions are there to ensure that you use the unit safely. Keep these operating instructions in a place that is accessible at all times to anyone who will be using the unit.

You will achieve excellent cooking results with your iCombi Classic. Thanks to the intuitive user guidance, this is possible quickly and easily with minimal training.

We hope you enjoy using your iCombi Classic.

Yours

RATIONAL UK Limited

1.1 Product warranty

Register your unit now at www.rational-online.com/warranty and benefit from the 2-year warranty. You will also find the general warranty conditions and warranty services on this page.

RATIONAL assumes no liability for damage caused by unauthorised technical changes.

1.2 Target group

This document is intended for staff working in large and commercial kitchens.

The unit may not be used, cleaned, or maintained by the following groups of persons:

- Persons with reduced physical, sensory or mental capabilities
- Persons lacking experience and knowledge
- Children

Supervise children standing near the unit. Children may not play with the unit.

1.3 Intended use

The iCombi Classic has been developed for the preparation of hot food.

This unit may only be used commercially, such as in restaurant kitchens and large and commercial kitchens in hospitals, bakeries or butcheries. This unit may not be used outdoors. This unit may not be used for continuous industrial mass production of food.

All other uses are contrary to the intended purpose, and may be dangerous. RATIONAL AG assumes no liability for the consequences of using the unit contrary to the intended use.

1.4 Working with this manual

1.4.1 Explanation of symbols

The following symbols are used in this document to inform and guide you:

- ✓ This symbol marks conditions which must be met prior to performing an action.
 1. This symbol marks an action step you must perform.
 - > This symbol marks an interim result that you can use to assess the result of an action step.
 - >> This symbol marks a result that you can use to assess the end result of an action instruction.
 - This symbol marks a bulleted list.
 - a. This symbol marks a list.

1.4.2 Explanation of pictograms

The following pictograms are used in this document:

 Caution! Read the operating instructions before using the unit.

 General warning symbol

 Useful tips for simple use of your unit.

1.4.3 Explanation of safety messages

If you see the following safety messages, you are being warned about hazardous situations and instructed to avoid these situations.

DANGER

If you see the signal word DANGER, you are being warned about situations that lead to serious injury or death.

WARNING

If you see the signal word WARNING, you are being warned about situations that may lead to serious injury or death.

CAUTION

If you see the signal word CAUTION, you are being warned about situations that may lead to injury.

NOTICE

If you see this notice, you are being warned about situations that may cause damage to the unit.

1.4.4 Images

The images used in these operating instructions may differ from the actual unit.

1.4.5 Technical changes

We reserve the right to make technical changes in the interest of progress.

2 General safety instructions

The unit is designed to be safe and will not present any danger if used in a correct and proper way. These instructions describe how to use the unit correctly.

- Your unit must be installed by your RATIONAL Service Partner or qualified installer.
- Your unit must be maintained by your RATIONAL Service Partner.
- Do not modify the unit or the unit installation undertaken by your RATIONAL Service Partner.
- Do not use the unit if it is damaged. A damaged unit is not safe and can cause damage or fire.
- Do not use the unit if a glass panel on the cooking cabinet door is damaged. Contact your RATIONAL Service Partner and have them replace the glass panel on the cooking cabinet door.
- Do not place any objects on the unit.
- Do not store any flammable or combustible substances near the unit.
- Only use the unit at an ambient temperature of +10 °C to +40 °C.
- Avoid having heat sources, e.g. grill plates or deep-fat fryers, near the unit.
- During operation, ensure that the floor surrounding the unit is dry and non-slip.

Safety instructions before use

- Make sure the unit is at a temperature of at least + 5°C.
- Make sure that the air baffle in front of the fan wheel is locked at the top and bottom.
- Make sure that the hinging rack or the mobile oven rack are locked.
- Make sure that there are no residues from cleaner tablets in the cooking cabinet.
- If the unit is used again after a long period of downtime, rinse the hand shower through with at least 10 litres of water.

Safety instructions during use

- This will prevent scalding and burns:
 - Open the cooking cabinet door carefully during use. Hot steam may escape.
 - Wear personal protective equipment if you are removing accessories or objects from the hot cooking cabinet.
 - Only touch the unit on the control panel and the cooking cabinet door when in operation. The outer surfaces can reach temperatures of over 60°C.
 - Only slide containers with food into racks you can see into. Hot food can otherwise spill out when removing them from the unit.
- This will prevent fire and explosion hazards:

- Do not cook with highly flammable liquids such as alcoholic drinks in the unit. Highly flammable liquids can self-ignite when cooking. Before cooking food in highly flammable liquids, boil down the liquid for a longer time to reduce the alcohol content.
- With grilling and roasting applications, use a fat collector under the food.
- This will prevent injuries when working with transport trolleys, mobile oven racks or mobile plate racks:
 - Carefully push transport trolleys, mobile oven racks or mobile plate racks over thresholds and uneven floors to prevent them from tilting.
 - Apply the brakes on transport trolleys, mobile oven racks or mobile plate racks to prevent them from rolling away on uneven floors.
 - Secure the transport trolley to your unit before sliding a mobile oven rack or mobile plate rack into the unit or removing them from the unit.
 - Apply the container lock on the mobile oven rack and cover containers holding hot food when moving mobile oven racks. Hot food can otherwise spill out.
- To prevent material damage due to improper use of accessories:
 - Use only original RATIONAL accessories.
 - Use only the VarioSmoker to smoke food.
- Cold food is not to be added to the unit for rethermalization while hot food is being held.

Safety instructions after use

- Clean the unit after every use.
- To prevent corrosion in the cooking cabinet, leave the cabinet door slightly open if it is going to be idle for a prolonged period and overnight.
- For long stoppages, shut off the water, power and gas supplies to the unit.
- For long stoppages and prior to transportation of the unit, empty the steam generator.

2.1 Safety instructions for units with a gas connection

- This will prevent fire hazards:
 - If your unit is connected to a chimney, contact your gas installer regularly to clean the ventilation pipe of the unit. Ensure that the provisions specific to the country are complied with.
 - Do not put objects on the exhaust pipes.
- This will prevent fatal accidents:
 - If your unit is operated with a exhaust hood, always switch on the exhaust hood during operation. Combustion gases may otherwise accumulate.
- If you smell gas, proceed as follows:

- Do not press any light or unit switches, do not pull any plugs from sockets and do not use mobile telephones or phones. This may cause sparks and increase the risk of an explosion.
- Open the windows and doors and ventilate the room with fresh air. Do not switch on any exhaust hoods or ventilators to ventilate the room. This may cause sparks and increase the risk of an explosion.
- Close the shut-off valve on the gas line.
- Leave the building and contact your gas supplier or the fire services.

2.2 Personal protective equipment

- When working with the unit, only wear clothing that cannot cause a work accident, particularly due to heat, splashing hot liquids or corrosive substances.
- Wear protective gloves for reliable protection when handling hot objects and sharp-edged trays.
- Wear tight-fitting protective glasses and chemical-safe protective gloves when cleaning to ensure reliable protection when handling care products.

3 The iCombi Classic



Model 10-1/1



Model 6-1/1



Model 6-2/1



Model 10-2/1

4 How to work with the unit

4.1 Initial start-up

When starting up your unit for the first time, it has already been properly installed by a RATIONAL Service Partner. The self-test has already been performed and the unit is therefore ready for operation. You can find all the information on installation in the installation manual enclosed.

Before working with the unit for the first time

1. Clean the unit and accessories before using the unit for the first time.

Click here for more information: Care [▶ 47]

4.2 Switching the unit on and off

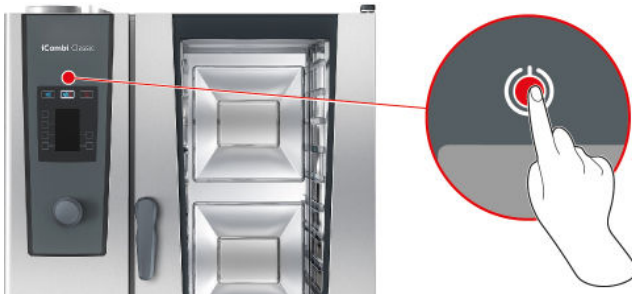

1. To switch on the unit, press the button for about 3 seconds: (⏻)
> The unit will start. The start screen will appear.
2. To switch off the unit, press and hold the button until the status bar at the top of the display is completely displayed: (⏻)
>> The unit will be switched off.

4.3 Interacting with the unit

NOTICE

Incorrect operation of the display

The display could be damaged if you operate it with a sharp object.

1. Only operate the unit with your fingers.

You can operate your unit with only one move and the central dial.



Press



Turn and press

1. Press the control panel button to select the desired mode or function.
2. Turn the central dial to apply your setting.
3. Press the central dial to confirm your setting.

4.4 Maximum load sizes

NOTICE

High load sizes could damage the unit

If you exceed the maximum load size, this may damage the unit.

1. Only load the unit with the maximum load sizes stated here

Model	Max. load size [kg]	Max. load per level
6-1/1	30 kg	15 kg
6-2/1	60 kg	30 kg
10-1/1	45 kg	15 kg
10-2/1	90 kg	30 kg

4.5 Opening and closing the cooking cabinet door



Safety door lock

Opening cooking cabinet door

1. Turn the cooking cabinet door handle to the right.
2. If your unit is equipped with a safety door lock, turn the cooking cabinet door to the left first and then to the right.
3. Open the cooking cabinet door slowly. **⚠ CAUTION! Scalding hazard!! If the unit is in operation, hot steam may surge out of the cooking cabinet.**

>> The fan wheel is slowed down.

Closing the cooking cabinet door

1. Press the cooking cabinet door firmly.

4.6 Loading the unit

1. Open the cabinet door.
 - > The brakes on the fan wheel will be activated and will brake the fan wheel.
2. Push the food into the unit.
3. If you are grilling or frying the food, push a container under the food to collect the fat.
4. Close the cooking cabinet door. Make sure that the cooking cabinet door is fully closed and the cooking cabinet door handle is in the vertical position.

Rack level over 1.60 m



If your unit has been installed so that the top rack is 1.60 m above the floor, you must apply the warning symbol supplied at that position.

4.6.1 Loading the unit with the mobile oven rack or the mobile plate rack

WARNING

If you are transporting mobile oven racks that are loaded with containers that contain hot food and that are not covered, hot food can spill over

You may scald yourself if you touch hot food.

1. Cover containers filled with hot liquids or hot food during transport in mobile oven racks.

CAUTION

Transport trolleys and mobile oven racks can move when being loaded or unloaded

If you do not apply the parking brakes before loading or unloading the transport trolley or mobile oven rack, the trolleys could move and injure you.

1. Apply the parking brakes on the castors before loading or unloading the transport trolley or mobile oven rack.



1. Remove the hinging rack.
2. Place the run-in rail for the mobile oven rack on the floor of the cooking chamber, so that the 2 fixing pins are inserted in the recesses intended for them in the rear part of the cooking chamber.
3. Press firmly on the front part of the run-in rail so that the run-in rail is fixed in the cooking cabinet.
4. Move the transport trolley as far as it will go on the unit (A).
5. Press the lever on the transport trolley (B).
 - > The transport trolley is now locked on the run-in rail.
6. Apply the parking brakes of the transport trolley (C).
7. Now push the mobile oven rack or the mobile plate rack into the cooking cabinet as far as it will go in the run-in rail.
8. Press the lever (D).
 - > The transport trolley lock is released.
9. Release the locking brakes on the transport trolley.
10. Take the transport trolley away from the unit to its storage location.
11. Close the cooking cabinet door. Make sure that the cooking cabinet door is fully closed.

4.6.2 Loading the Combi-Duo with the mobile oven rack or the mobile plate rack

WARNING

If you are transporting mobile oven racks that are loaded with containers that contain hot food and that are not covered, hot food can spill over

You may scald yourself if you touch hot food.

1. Cover containers filled with hot liquids or hot food during transport in mobile oven racks.

CAUTION

Transport trolleys and mobile oven racks can move when being loaded or unloaded

If you do not apply the parking brakes before loading or unloading the transport trolley or mobile oven rack, the trolleys could move and injure you.

1. Apply the parking brakes on the castors before loading or unloading the transport trolley or mobile oven rack.



1. Remove the hinging rack.
2. Place the run-in rail for the mobile oven rack on the floor of the cooking cabinet so that the 2 fixing pins are inserted in the recesses intended for them in the rear part of the cooking cabinet.
3. Press firmly on the front part of the run-in rail so that the run-in rail is fixed in the cooking cabinet.
4. Move the transport trolley as far as it will go on the unit.
5. To load the top unit of the Combi-Duo, press the lever on the transport trolley and pull the handle towards you (A).
 - > The transport trolley is now locked on the run-in rail.
6. Now push the mobile oven rack or the mobile plate rack into the cooking cabinet as far as it will go in the run-in rail.
7. Pull the lever on the right side of the mobile oven rack or mobile plate rack towards you and apply the brakes. This ensures that the mobile oven rack or mobile plate rack remains securely in the cooking cabinet.
8. Apply the parking brakes of the transport trolley.
9. Press the lever on the transport trolley back to its original position.
 - > The transport trolley lock is released.
10. To load the bottom unit of the Combi-Duo, press the lever on the transport trolley forwards and then pull the handle upwards (B).
 - > The transport trolley is now locked on the run-in rail.
11. Now push the mobile oven rack or the mobile plate rack into the cooking cabinet as far as it will go in the run-in rail.
12. Pull the lever on the right side of the mobile oven rack or mobile plate rack towards you and apply the brakes. This ensures that the mobile oven rack or mobile plate rack remains securely in the cooking cabinet.
13. Press the lever on the transport trolley back to its original position.
 - > The transport trolley lock is released.
14. Take the transport trolley away from the unit to its storage location.
15. Close the cooking cabinet doors. Make sure that the cooking cabinet doors are fully closed.

4.7 Inserting core temperature probe

The following sections describe how to work both with the core probe and with the externally attachable core probe.

CAUTION

Hot core probe

There is a risk of burns if you touch the hot core probe without protective gloves.

1. Always wear protective gloves when working with the hot core probe.
2. If necessary, cool down the core probe using the hand shower.

CAUTION

Sharp core probe

You could injure yourself with the tip of the core probe if you do not work carefully with it.

1. Always wear protective gloves when working with the hot core probe.
2. After use, insert the core probe into the holder provided.

NOTICE

The core probe is hanging out the cooking cabinet

If you do not insert the core probe into the holder provided after use, the core probe may be damaged.

1. After use, insert the core probe into the holder provided.



TIP

- If you regularly cook very thin or liquid food, it is recommend to use the optional positioning aid. First insert the core probe in the positioning aid and then into the food.
- If the core probe is warmer than the set core temperature, cool down the core probe using the hand shower.

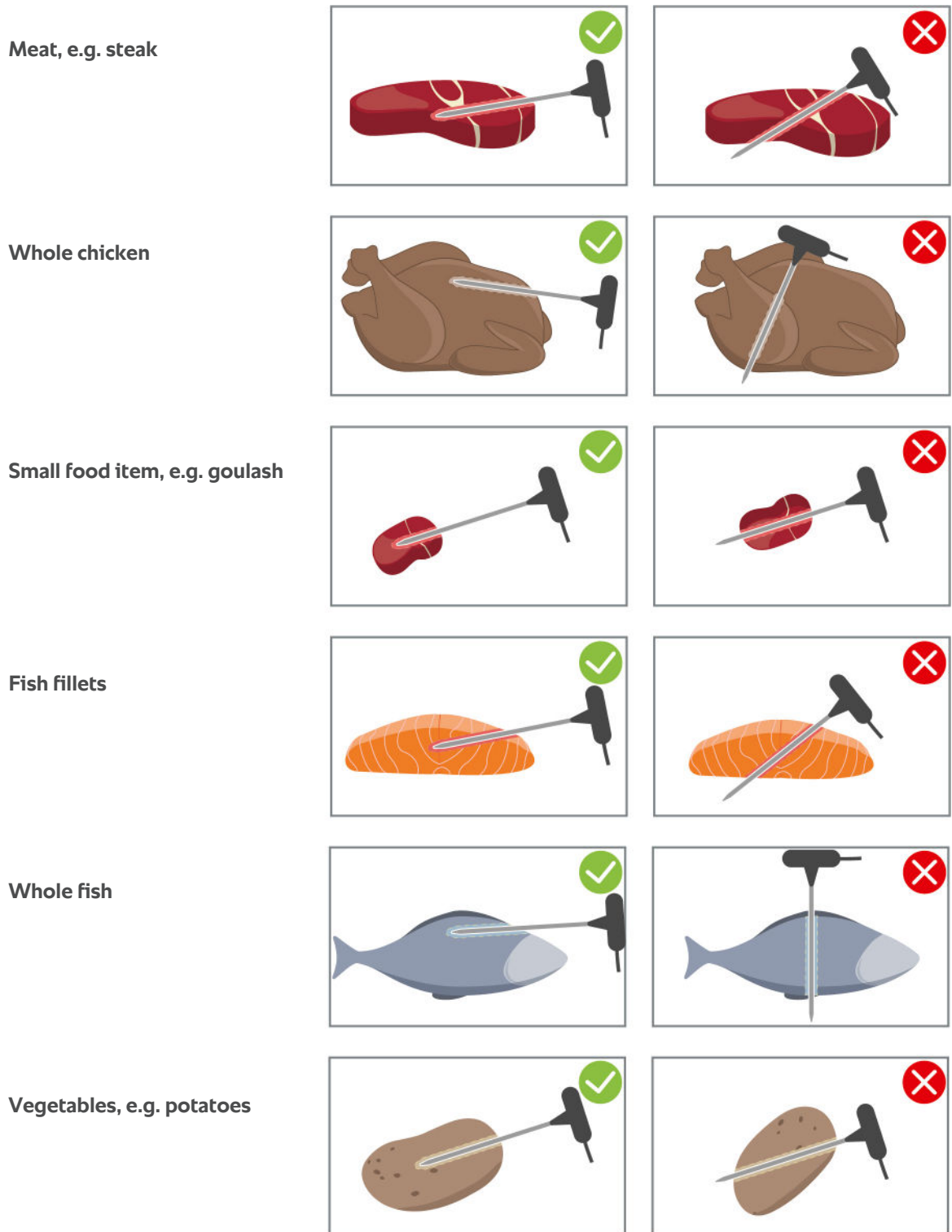

Meat, e.g. steak

1. Insert the core probe at an angle into the food so that the tip of the core probe is in the thickest part of the food.

Large pieces of meat, e.g. roasts

1. Insert the core probe into the food so that the tip of the core probe is in the thickest part of the food.

Whole chicken

1. Insert the core probe into the thickest point of the breast fillet, not too close to the ribs.

Make sure that the tip of the core probe does not protrude into the abdominal cavity of the chicken. Do not insert the core probe into the leg.

Fish fillets

1. Insert the core probe at an angle into the food so that the tip of the core probe is in the thickest part of the food.

Whole fish

1. Insert the core probe into the food so that the tip of the core probe is in the thickest part of the food. Make sure that the tip of the core probe does not protrude into the abdominal cavity of the fish.

Small food item, e.g. goulash

1. Insert the core probe into the food so that the tip of the core probe is in the thickest part of the food.

Soups, sauces, desserts

1. Place the core probe in the Gastronorm container so that the core probe is completely covered with liquid.
2. If you stir the liquid, leave the core probe in the Gastronorm container.

Vegetables, e.g. potatoes

1. Insert the core probe into the food so that the tip of the core probe is in the thickest part of the food.

Baked goods

1. For baked goods that rise during baking, place the core probe vertically in the middle of the product. To do this, use the optional positioning aid.

Food of different sizes

1. First insert the core probe into the smallest piece of the food.
2. Once the desired core temperature has been reached, remove the small pieces of food from the core probe and from the cooking cabinet.
3. Then insert the core probe into a larger piece of the food and continue cooking.

Finishing with mobile plate rack

1. Insert the core probe in the white ceramic tube of the mobile plate rack.

Remove core probe

1. Once the food has reached the desired core temperature, first remove the core probe from the food and then the food from the cooking cabinet.
2. Insert the core probe into the holder provided.

4.8 Using the hand shower

The hand shower has two adjustable spray patterns, spray  (A) and jet  (B).

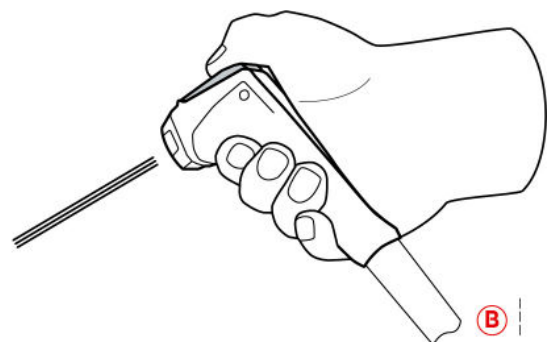

⚠ CAUTION**The hand shower and the water coming out of the hand shower can reach over 60 °C**

You could burn yourself if you touch hot components or come in contact with hot water.

1. Wear protective gloves while working with the hand shower.

⚠ CAUTION**Germ formation in the water pipe**

If you do not use the hand shower daily, germs may form in the water line.

1. Rinse the hand shower through with water in the morning and in the evening for 10 seconds.

NOTICE**Improper handling of the hand shower**

If you pull the hand shower out beyond the maximum hose length or rip the hose, the automatic retraction system of the hand shower may be damaged. Then hand shower will no longer automatically retract into the housing.

1. Do not pull the hand shower beyond the maximum hose length.

NOTICE**The hand shower is not suitable for cooling down the cooking cabinet**

If you cool down the cooking cabinet with the hand shower, this could damage the cooking cabinet, air baffle or the glass panels of the cooking cabinet door.

1. Only cool down the cooking cabinet using the cool down function.

1. Pull the hand shower at least 20 cm out of the park position.
2. Hold the hand shower hose firmly.
3. Turn the front part of the hand shower to select the desired spray pattern.
 - Set the hand shower to | to select the **jet** spray pattern.
 - Set the hand shower to  to select the **spray** pattern.

If you do not turn the front part of the hand shower to one of the two spray patterns, water can drip from the shower head.

1. Press the lever on the hand shower. The harder you press the lever, the stronger the water stream will be.
2. After use, let the hand shower slowly retract into the housing. **⚠ CAUTION! Make sure that the hose of the hand shower is clean before letting it retract into the housing.**

4.9 Removing hinging rack

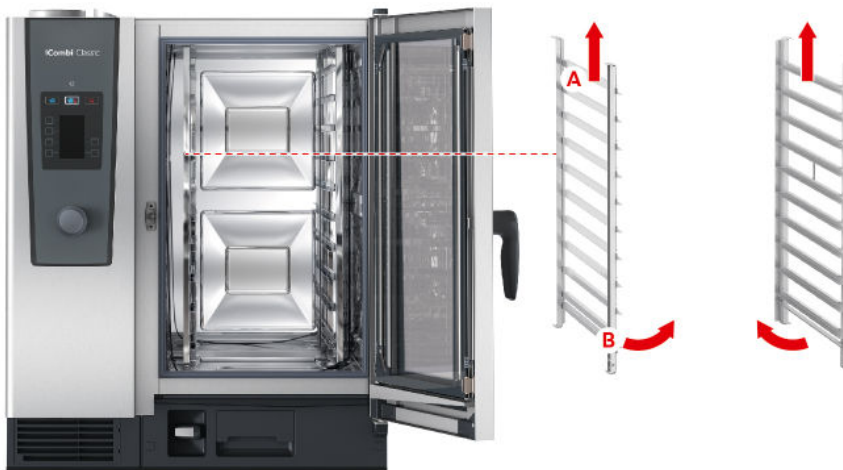

1. Hold the hinging rack in the middle of the top trays.
2. Press the hinging rack upwards (A).
3. Tilt the left hinging rack in the cooking cabinet (B).
4. Take the hinging rack off the hinges and remove it from the cooking cabinet.

4.10 Integrated fat drain

If your unit is equipped with the optional integrated fat drain, dripping fat is collected in the cooking chamber and directed into the fat collecting container.

1	Ball valve handle	2	Drain pipe
3	Filler pipe with bayonet fastener	4	Grease drip collector

1. Open the cabinet door.
 2. Remove the drain pipe fastener.
 3. Place the fat collecting tray in the cooking chamber, so that the opening of the fat collecting tray is on the drain pipe.
 4. Place a fat container under the drain on the outside of the unit, e.g. a canister.
 5. Insert the filler pipe of the integrated fat drain into the fat collecting container.
 6. Insert the bayonet fastener of the filler pipe onto the drain.
 7. Lock the bayonet fastener.
 8. Turn the handle of the ball valve to a horizontal position.
- >> The ball valve is open. Dripping fat can now be collected in the fat collecting container.

Replace the fat collecting container

CAUTION

The outside of the unit, the drain and the fat collecting container can get very hot

You can burn yourself if you come into contact with hot functional parts.

1. Wear your personal protective equipment when changing the fat collecting container.

1. When the fat collecting container is full, turn the handle of the ball valve to the vertical position.
 - > The ball valve is closed.
2. Loosen the bayonet fastener.
3. Replace the fat collecting container.

4. Dispose of the fat properly. **NOTICE! Fat and other liquid substances that are collected in the fat collecting container must be disposed of in compliance with legal requirements. Never dispose of fat in the drain. Never use fat that you have collected in the fat collecting container to cook food or as food.**

5 Preparing food

5.1 Open modes

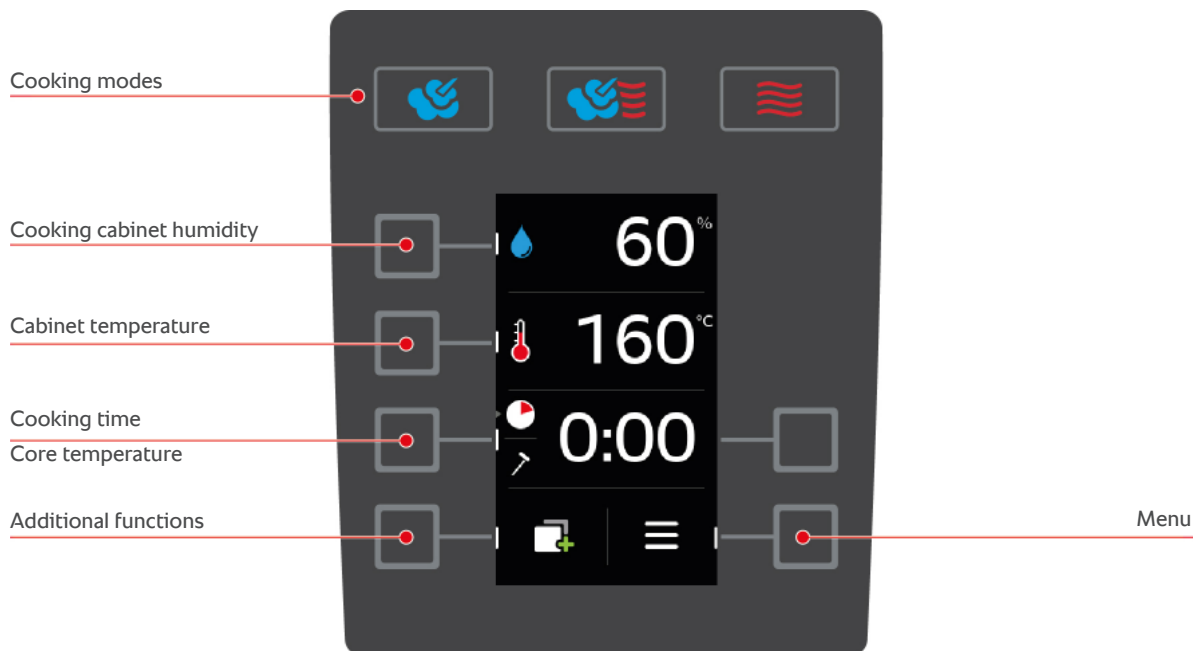

- The following modes are available:
 - Steam [▶ 26]
 - Combination of steam and hot air [▶ 27]
 - Convection [▶ 28]
- You can choose from the following cooking parameters [▶ 23]:
 - Cooking cabinet humidity
 - Cabinet temperature
 - Cooking time
 - Core temperature
- You can choose from the following additional functions [▶ 25]:
 - Heat
 - Cool-down function
 - Air speed
 - Delta-T cooking

5.2 Cooking parameters



Cooking cabinet humidity

With this cooking parameter, you can set the humidity in the cooking cabinet.

- In the **Steam** mode, the cooking cabinet humidity is 100 % and cannot be changed.
- In the **Combination of steam and hot air mode**, extra humidity is injected by the steam generator in addition to the humidity from the food. If the set cooking cabinet humidity is exceeded, the cooking cabinet will be dehumidified.
- In the **Hot Air Mode**, the humidity is not injected by the steam generator, but comes from the food. If the set cooking cabinet humidity is exceeded, the cooking cabinet will be dehumidified.

This is how you set the cooking cabinet humidity:

1. Press the button 





2. Turn the central dial and set the desired cooking cabinet humidity.
3. Press the central dial to confirm your setting.



Cabinet temperature

With this cooking parameter, you can set the temperature in the cooking cabinet.

This is how you set the cooking cabinet temperature:

1. Press the button 
2. Turn the central dial and set the desired cooking cabinet temperature.
3. Press the central dial to confirm your setting.
 - > If the actual temperature is higher than the set cooking chamber temperature,  starts to flash.
4. Press the button 
5. Press the button 
 - > You will be asked to open the cooking chamber door.
 - > **⚠️ WARNING! Risk of injury! When you open the cooking cabinet door, the fan wheel will not slow. Do not reach into the rotating fan wheel.** The speed of the fan wheel will increase. The cooking cabinet temperature will fall. The cooking chamber temperature is shown in the display.
6. When the desired cooking chamber temperature has been reached, press the button: 

>> The cool-down function is ended.

You can view the current cooking cabinet humidity and cooking cabinet temperature as follows:



1. Press and hold the button: 
 - > After 10 seconds, the current cooking cabinet temperature will be displayed.
2. To revert to the set parameter values, release the button.



Cooking time

With this cooking parameter, you can set the time in which the food will reach the desired cooking result. Alternatively, you can let your unit run uninterrupted with the settings you apply. To do this, select continuous operation.

This is how you set the cooking time:

1. Press the button 
2. Turn the central dial and set the desired cooking time.
 - > If you set the cooking time to 10:00, this symbol will appear:  Continuous operation is on.
3. Press the central dial to confirm your setting.

If you have set the cooking time, the **core temperature** cooking parameter will not be available.



Core temperature

With this cooking parameter, you can set how high the core temperature or the cooking level of the food should be.

This is how you set the core temperature:

1. Press this button twice: 
2. Turn the central dial and set the desired core temperature.
3. Press the central dial to confirm your setting.

Please adhere to the applicable hygiene regulations for the relevant food in your country when setting the core temperature.

5.3 Additional functions



Heat

With this additional function, the cooking cabinet is preheated in order to produce a thermal buffer.

This is how you set the temperature to which the unit should preheat.

1. Press the button
 2. Press the button
 3. Turn the central dial and set the desired temperature.
 4. Press the central dial to confirm your setting.
 - > The unit is preheated.
 5. To stop the preheating, press the button:
 6. To display the current cooking chamber temperature, press and hold the button:
- >> When the unit is preheated, you will be asked to load it.



Cool-down function

If you have cooked food at high temperatures, and then need a lower cooking cabinet temperature, you can cool down the cooking cabinet using the cool down function.

- ✓ The air baffle is correctly locked.
1. Press the button
 2. Press the button
 3. **⚠ WARNING! Scalding hazard! When you open the cooking cabinet door, hot steam will surge out of the cooking cabinet.** Open the cabinet door. If the cooking chamber door is already open, close the cooking chamber door and then open it again.
 - > **⚠ WARNING! Risk of injury! When you open the cooking cabinet door, the fan wheel will not slow. Do not reach into the rotating fan wheel.** The speed of the fan wheel will increase. The cooking cabinet temperature will fall. The cooking chamber temperature is shown in the display.
 4. When the desired cooking chamber temperature has been reached, press the button:
- >> The cool-down function is ended.



Air speed

With this additional function, you can set the speed of the fan wheel. The higher the selected level, the higher the air speed will be. Select a lower level for small delicate food.

This is how you set the air speed:

1. Press the button
2. Press the button
3. Turn the central dial and set the desired air speed.
4. Press the central dial to confirm your setting.





Delta-T cooking

With this additional function, food is cooked while maintaining a constant difference between the cooking cabinet temperature and core temperature. By slowly increasing the cooking cabinet temperature with a constant difference with the core temperature, the food is cooked slowly and very gently. This minimises cooking losses. You can set a difference between 20 °C and 60 °C. Then you must set the desired core temperature.

The smaller the difference between the cooking cabinet temperature and the core temperature, the slower and more gently the food will be cooked. The bigger the difference between the cooking cabinet temperature and the core temperature, the faster the food will be cooked.

This is how you set the Delta-T cooking:

1. Press the button

2. Press the button 
 - > You automatically return to the cooking parameters. The **cooking time** cooking parameter is then replaced with the **Delta-T cooking** function. The current cooking chamber temperature and the delta temperature are displayed.
3. Press the button 
4. Turn the central dial and set the desired temperature difference.
5. Press the central dial to confirm your setting.
 - > The selection will automatically return to the **core temperature** cooking parameter.
6. Turn the central dial and set the desired core temperature.
7. Press the central dial to confirm your setting.
 - >> The cooking parameters are displayed according to your settings.



5.4 Steam

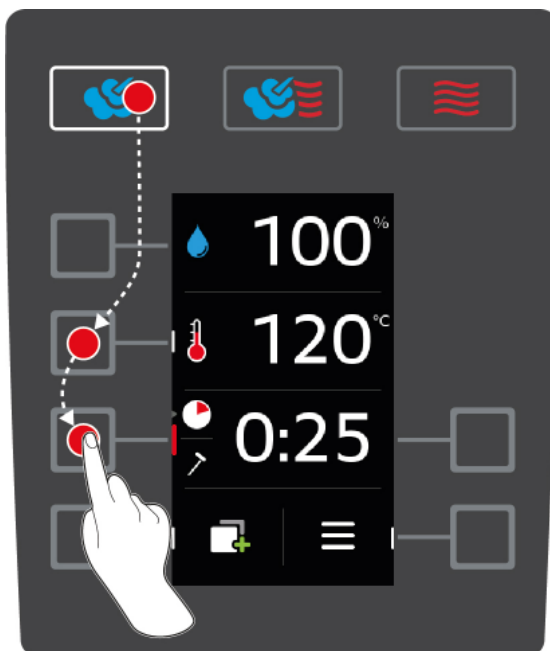

5.4.1 Cooking climate and temperature range

Cooking cabinet climate	Cooking methods	Cooking cabinet humidity	Cabinet temperature
moist	<ul style="list-style-type: none"> ▪ Steam ▪ Stew ▪ Blanch ▪ Heat through ▪ Soak ▪ Sous-vide cooking ▪ Defrost ▪ Preserve 	100 %	30 – 130 °C

5.4.2 Cooking food in steam



1. Press the button 
2. Press the button 
3. Turn the central dial and set the desired cooking cabinet temperature.
4. Press the central dial to confirm your setting.

- > The selection of cooking parameters will automatically return to the **cooking time**  cooking parameter.
- 5. Turn the central dial and set the desired cooking time.
- 6. Press the central dial to confirm your setting.
- 7. To cook the food with the core temperature, press this button once: 
- 8. Turn the central dial and set the desired core temperature.
- 9. Press the central dial to confirm your setting.
 - > Once the set cooking cabinet temperature has been reached, you will be prompted to load the unit. If you do not load the unit, the preheat will be aborted after 10 minutes.
- 10. Load the unit.
 - > The food will be cooked. If the cooking time has elapsed or the core temperature has been reached, an acoustic signal will ask you to check whether the food has reached the desired result.

5.5 Combination of steam and hot air



5.5.1 Cooking climate and temperature range

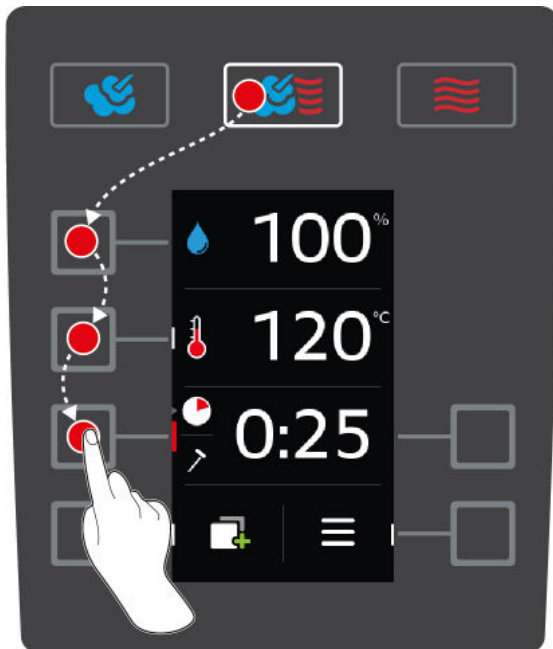

Cooking cabinet climate	Cooking methods	Cooking cabinet humidity	Cabinet temperature
humid and hot	<ul style="list-style-type: none"> ▪ Bake ▪ Fry 	0 - 100 %	30 – 300 °C

If the cabinet temperature is above 260 °C for 30 minutes, the temperature will be automatically reduced to 260 °C if you do not work with the unit within this period. If you perform an action within these 30 minutes, such as opening the cooking cabinet door, then the cooking cabinet temperature will be held at 260 °C for another 30 minutes.

5.5.2 Cooking the food in the combination of steam and hot air



1. Press the button 
2. Press the button 
3. Turn the central dial and set the desired cooking cabinet humidity.
4. Press the central dial to confirm your setting.
 - > The selection of cooking parameters will automatically return to the **cooking cabinet temperature**  cooking parameter.
5. Turn the central dial and set the desired cooking cabinet temperature.

6. Press the central dial to confirm your setting.
 - > The selection of cooking parameters will automatically return to the **cooking time**  cooking parameter.
7. Turn the central dial and set the desired cooking time.
8. Press the central dial to confirm your setting.
9. To cook the food with the core temperature, press this button once: 
10. Turn the central dial and set the desired core temperature.
11. Press the central dial to confirm your setting.
 - > Once the set cooking cabinet temperature has been reached, you will be prompted to load the unit. If you do not load the unit, the preheat will be aborted after 10 minutes.
12. Load the unit.
 - > The food will be cooked. If the cooking time has elapsed or the core temperature has been reached, an acoustic signal will ask you to check whether the food has reached the desired result.

5.6 Convection

5.6.1 Cooking climate and temperature range



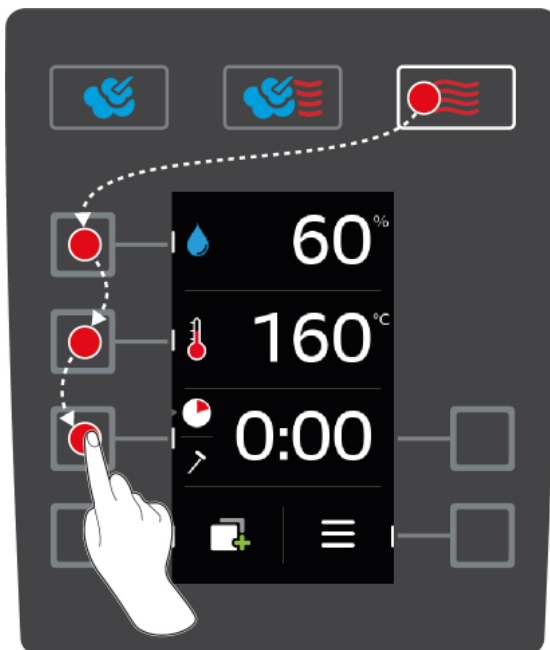

Cooking cabinet climate	Cooking methods	Cooking cabinet humidity	Cabinet temperature
hot	<ul style="list-style-type: none"> ▪ Bake ▪ Fry ▪ Grill ▪ Deep-fry ▪ Gratinate ▪ Glaze 	0 - 100 %	30 – 300 °C

If the cabinet temperature is above 260 °C for 30 minutes, the temperature will be automatically reduced to 260 °C if you do not work with the unit within this period. If you perform an action within these 30 minutes, such as opening the cooking cabinet door, then the cooking cabinet temperature will be held at 260 °C for another 30 minutes.

5.6.2 Cooking food in convection heat



1. Press the button 

2. Press the button .
3. Turn the central dial and set the maximum cooking cabinet humidity.
4. Press the central dial to confirm your setting.
 - > The selection of cooking parameters will automatically return to the **cooking cabinet temperature**  cooking parameter.
5. Press the central dial to confirm your setting.
 - > The selection of cooking parameters will automatically return to the **cooking time**  cooking parameter.
6. Turn the central dial and set the desired cooking time.
7. Press the central dial to confirm your setting.
8. To cook the food with the core temperature, press this button once: .
9. Turn the central dial and set the desired core temperature.
10. Press the central dial to confirm your setting.
 - > Once the set cooking cabinet temperature has been reached, you will be prompted to load the unit. If you do not load the unit, the preheat will be aborted after 10 minutes.
11. Load the unit.
 - > The food will be cooked. If the cooking time has elapsed or the core temperature has been reached, an acoustic signal will ask you to check whether the food has reached the desired result.

6 Sous-vide cooking

In sous-vide cooking, food is prepared, seasoned, marinated or seared, vacuum-packed in a sous-vide bag and then cooked. This intensifies the food's own flavour, preserves the natural colours, precious vitamins and minerals are retained and cooking losses are reduced thanks to the gentle cooking. After cooking, the food must be cooled. Before the food is served, it is reheated still in the plastic bag, then removed from the bag and then finished according to the final dish.

Sous-vide cooking is particularly suitable for the following uses:

- Cook and chill

Produce your dishes centrally in a production kitchen and then deliver the dishes to satellite kitchens. This avoids expensive over-production, as you only finish the dishes you actually need.

- Room service

Produce your dishes or individual components, cool them down and finish the individual portions to order. This means even untrained kitchen staff can cater for your guests 24 hours a day.

- Special diets and clean eating

Gently produce healthy dishes and preserve the natural flavours and aromas. With the addition of aromatics, even unsalted dishes can taste naturally rich.

7 Finishing

Using Finishing, you can separate your food production from service and thus give yourself some freedom for the important things in cooking: planning, menu design or creative plating. Quality losses from keeping food warm are minimised and perfect food quality is assured.

- Only finish the foods that you actually need, adjust the required food to your guest numbers.
- Avoid rushing and stress when plating thanks to shorter production and service times.
- Reduce staff costs with efficient time management and shorter paths to the guest.
- Hold multiple events simultaneously and increase your occupancy, without any additional costs.

With Finishing, you can produce perfect food quality in a wide variety, whether in a restaurant, hotel or industry catering:

- Finishing in a restaurant
The food is finished exactly when you need it.
- Finishing in a hotel
Plated Finishing is particularly ideal when you need to serve many plates at the same time, e.g. at conferences, weddings or catering events.
- Finishing in industry catering
Container Finishing is ideal when you need to offer a wide variety of food in large quantities.

You can either finish food manually [[▶ 31](#)] or with the help of preset programmes [[▶ 33](#)].

7.1 Cooking climate and temperature



Cooking cabinet climate	Cooking cabinet humidity	Cabinet temperature
humid and hot	0 - 100 %	Boiling temperature – 140 °C

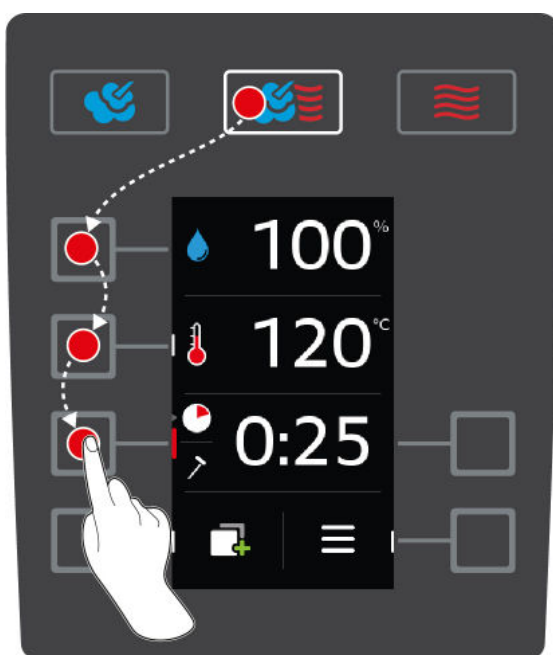

The temperature range between boiling temperature and 140 °C is ideal for finishing food. The food does not dry out and no humidity condensation on the plates.

7.2 Finishing food

You can also finish food using preset programmes. Click here for more information: [Pre-defined programme \[\[▶ 33\]\(#\)\]](#)



1. Press the button 
2. Press the button 



3. Turn the central dial and set the desired cooking cabinet humidity.
4. Press the central dial to confirm your setting.
 - > The selection of cooking parameters will automatically return to the **cooking cabinet temperature**  cooking parameter.
5. Turn the central dial and set a cooking cabinet temperature between boiling point and 140 °C.
6. Press the central dial to confirm your setting.
 - > The selection of cooking parameters will automatically return to the **cooking time**  cooking parameter.
7. Turn the central dial and set the desired cooking time.
8. Press the central dial to confirm your setting.
9. To cook the food with the core temperature, press this button once:  Insert the core probe in the white ceramic tube of the mobile plate rack.
10. Turn the central dial and set the desired core temperature.
11. Press the central dial to confirm your setting.
 - > Once the set cooking cabinet temperature has been reached, you will be prompted to load the unit. If you do not load the unit, the preheat will be aborted after 10 minutes.
12. Load the unit.
 - > The food will be regenerated. If the cooking time has elapsed or the core temperature has been reached, an acoustic signal will ask you to check whether the food has reached the desired result.

8 Programming mode

You can create and save your own cooking programmes in programming mode. There are 100 programme slots available. You can assign up to 12 cooking steps to each programme. For you this means it is easy to use, no checking, no monitoring. You therefore gain time, save raw materials and energy and always have outstanding, standardised food quality.

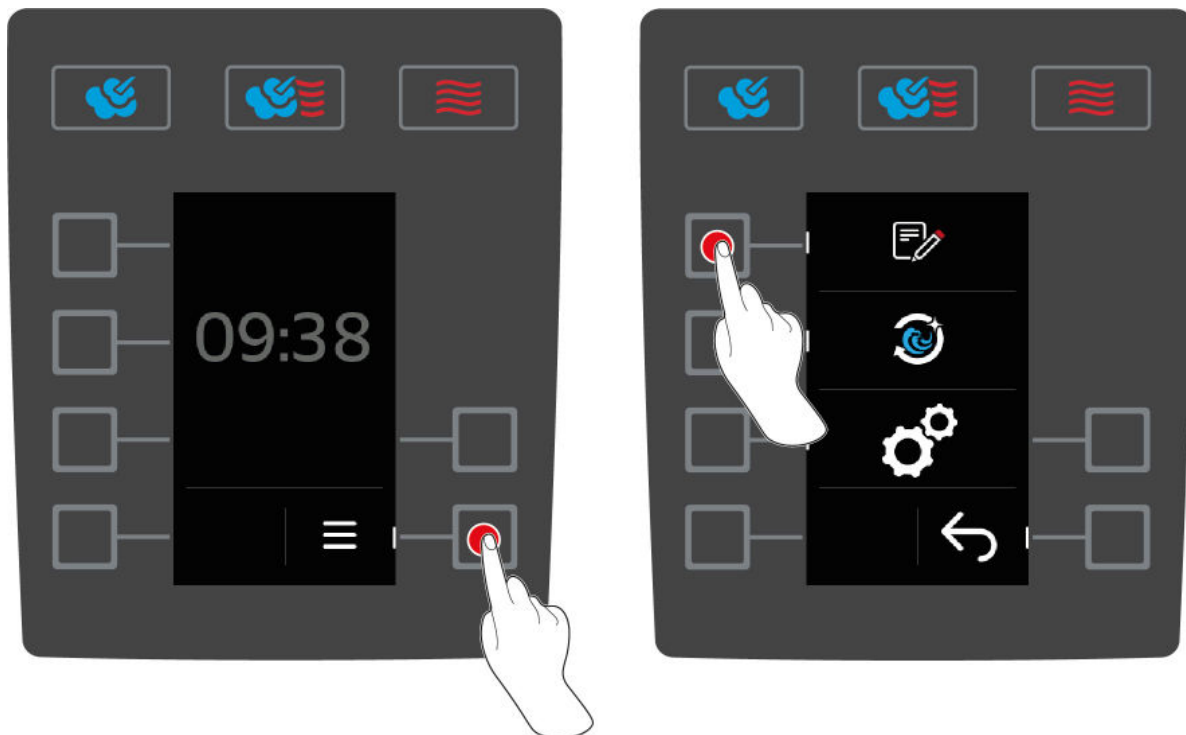
8.1 Start programming mode



1. Press the button on the start screen: 
 2. Press the button 
- >> The program list in the programming mode will be displayed.

8.2 Pre-defined programme

You can choose from the following preset programmes:

Programme	Steps	Settings
Container finishing with time	Step 1	<ul style="list-style-type: none"> ▪ Cooking mode: Combination of steam and hot air ▪ Preheat: 140 °C
	Step 2	<ul style="list-style-type: none"> ▪ Cooking cabinet temperature: 140 °C ▪ Cooking cabinet humidity: 60 % ▪ Fan level: 4 ▪ Core temperature: 68 °C
	Step 3	<ul style="list-style-type: none"> ▪ Cooking mode: Convection ▪ Cooking cabinet temperature: 140 °C ▪ Cooking cabinet humidity: 60 % ▪ Fan level: 4 ▪ Core temperature: 72 °C
Container finishing with core temperature	Step 1	<ul style="list-style-type: none"> ▪ Cooking mode: Combination of steam and hot air ▪ Preheat: 140 °C

Programme	Steps	Settings
	Step 2	<ul style="list-style-type: none"> ▪ Cooking cabinet temperature: 140 °C ▪ Cooking cabinet humidity: 60 % ▪ Fan level: 4 ▪ Cooking time: 24 minutes
	Step 3	<ul style="list-style-type: none"> ▪ Cooking mode: Convection ▪ Cooking cabinet temperature: 140 °C ▪ Cooking cabinet humidity: 60 % ▪ Fan level: 4 ▪ Cooking time: 1 minute
Plate finishing	Step 1	<ul style="list-style-type: none"> ▪ Cooking mode: Combination of steam and hot air ▪ Preheat: 130 °C
	Step 2	<ul style="list-style-type: none"> ▪ Cooking cabinet temperature: 130 °C ▪ Cooking cabinet humidity: 80 % ▪ Fan level: 4 ▪ Cooking time: 8 minutes

You can find further information on finishing here [▶ 31].

8.3 Create new programme

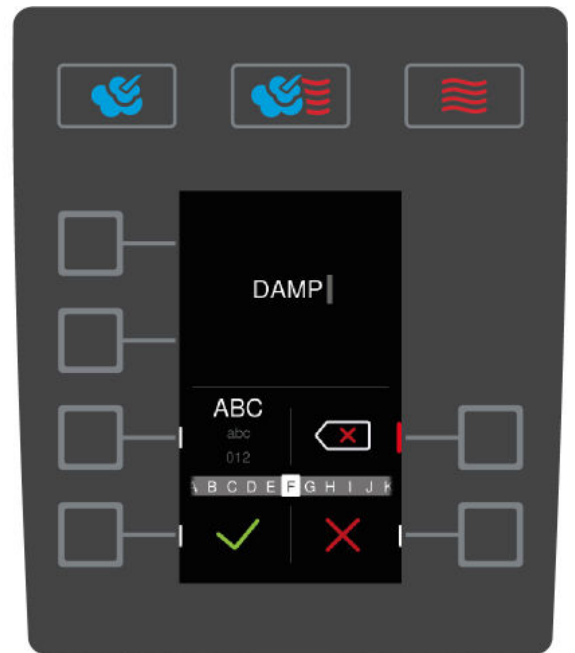
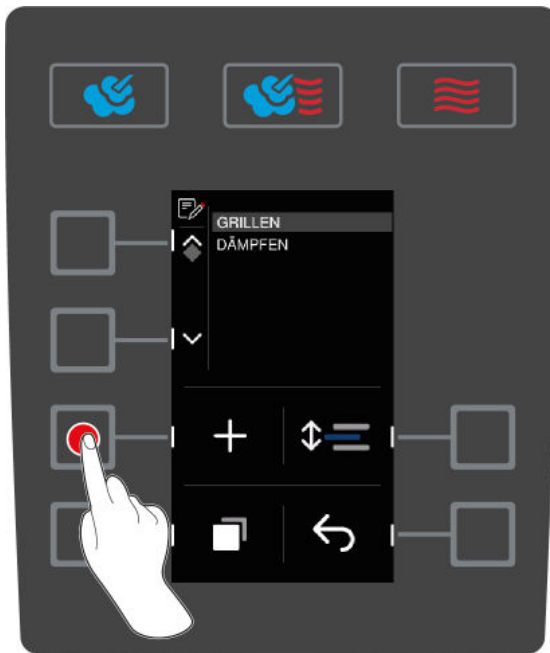

1. Press the button on the start screen:
2. Press the button
3. Press the button
4. Enter the program name using the central dial. You can use upper case and lower case letters and figures. To switch between options, press this button: **ABC**
5. To correct an entry, press this button:
6. Once you have entered the programme name, press the button to confirm your entry:
- > The operating mode buttons will start flashing.
7. Select the desired mode.
 - > The mode button will start flashing.

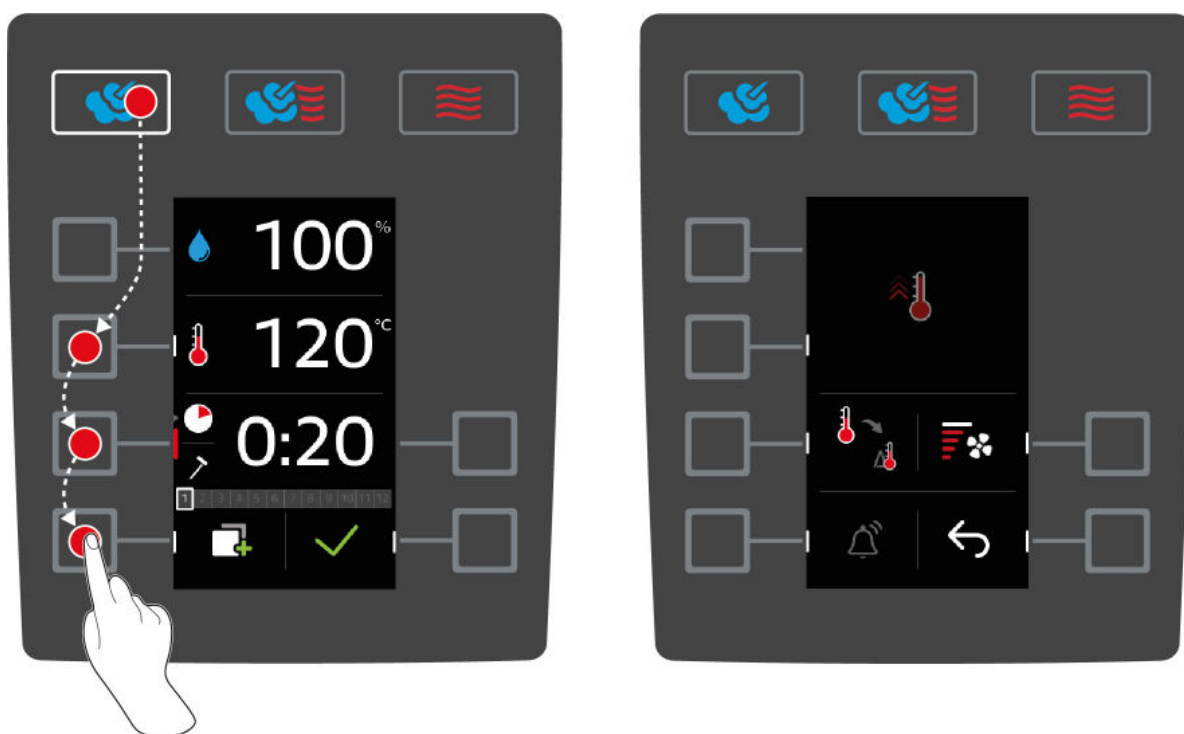





Programme cooking step

Depending on which cooking step you have selected, you can select different cooking parameters [► 23]. You can also select different additional functions [► 25].

1. Press the button for a desired cooking parameter.
 2. Turn the central dial to apply your setting.
 3. Press the central dial to confirm your setting.
 4. To confirm the action, press the button: ✓
- > The cooking step is saved and will be displayed. You can now add up to 11 more cooking steps.

Manual preheating

You can create a step in the programme to preheat the unit. This will produce a thermal buffer in the cooking cabinet to help the cooking cabinet reach the desired cabinet temperature very quickly, even when cooking frozen foods.

1. Press the button 
 2. Press the button 
 3. Press the button 
 4. Press the button 
 5. Turn the central dial and set the desired temperature.
 6. To confirm the action, press the button: ✓
- > The manual preheat is created as the first step in the programme.
7. To program another cooking step, press the button: 
 - > The operating mode buttons will start flashing.
 8. Select the desired mode and continue programming the cooking step.



Add another cooking step

1. Press the button 
 - > The operating mode buttons will start flashing.
2. Select the desired mode and continue programming the cooking step.

Edit cooking step

1. To edit the cooking step, press the button: 
2. Select the desired mode and edit the cooking parameter.



Delete cooking step

1. To delete the cooking step, press the button: 
- >> The cooking step will be deleted.



Save programme



1. To save the programme, press the button: 
- >> The programme will be displayed in the programme list at the bottom level. You can now start the programme [▶ 36].

8.4 Start programme



1. Press the button 
2. Press the button 
3. Turn the central dial and select the desired programme.
4. Press the central dial to confirm your selection.
- >> The programme will start and the first cooking step will be performed.

8.5 Edit programme



1. Press the button 
2. Press the button 
3. Turn the central dial and select the desired programme.
4. Press the button 

5. Press the button 
6. If you want to rename the cooking process, make your changes and press the button to confirm your changes: 



> You can choose from the following editing options:

- Add cooking step 
- Delete cooking step 
- Edit cooking parameter 



Add cooking step

1. Press the button 
 - > The operating mode buttons will start flashing.
2. Select the mode, the cooking parameters and the additional functions. Click here for more information: Create new programme [▶ 34]
3. To save the cooking step, press the button: 
4. To save the cooking process, press the button: 



Delete cooking step

1. Turn the central dial and select the desired cooking step.
2. Press the button 
 - > The cooking step will be deleted.
3. To save the cooking step, press the button: 
4. To save the cooking process, press the button: 

Edit cooking parameter

1. Turn the central dial and select the desired cooking step.
2. Press the button 
 - > The cooking parameters of the cooking step are displayed.
3. Select the mode, the cooking parameters and the additional functions you want to edit. Click here for more information: Create new programme [▶ 34]
4. To save the cooking step, press the button: 
5. To save the cooking process, press the button: 

8.6 Delete programme

1. Press the button 
 2. Press the button 
 3. Turn the central dial and select the desired programme.
 4. Press and hold the button until the status bar is completely displayed: 
- >> The programme is deleted.

8.7 Sort programme list

You can sort the programme list so that the most frequently used programmes are at the top:

- ✓ You have created programmes.
1. Turn the central dial and select the desired programme.
 2. Press the button 
 3. Turn the central dial until the programme is at the desired point.
 4. Press the central dial to confirm your setting.

8.8 Upload and download programmes

You can download programs you have created on one unit and transfer them to another iCombi Classic.



✓ You have connected a USB flash drive with the unit.

1. Press the button on the start screen:
2. Press the button
3. Press the button

Download programs

1. Press the button
 - > You can decide whether you only want to download one program or all programs.
2. Turn the central dial and select the desired program.
3. If you only want to download one program, press this button:
4. If you want to download all programs, press this button:
5. To start the download, press this button:
 - > The programs will be downloaded.

Upload programs

1. Press the button
 - > The programs will be uploaded and available:

9 Settings

9.1 Open settings

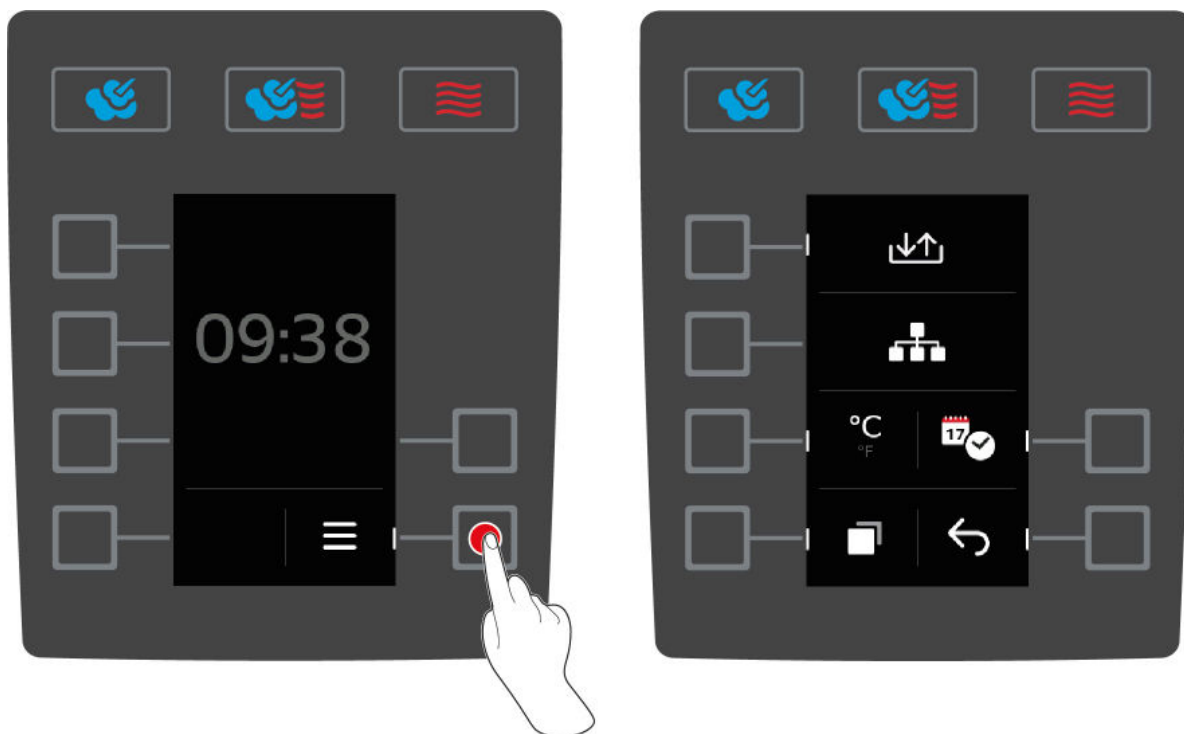

1. Press the button on the start screen: 

2. Press the button 

You can change the following settings:

- Set the temperature unit [▶ 39]
- Set date and time [▶ 40]

1. To open more settings, press this button: 

You can change the following settings:

- Switch keyboard [▶ 41]

1. To return to the start screen, press this button: 

9.2 Set the temperature unit

Here you can set whether the temperature should be displayed in °C or °F.

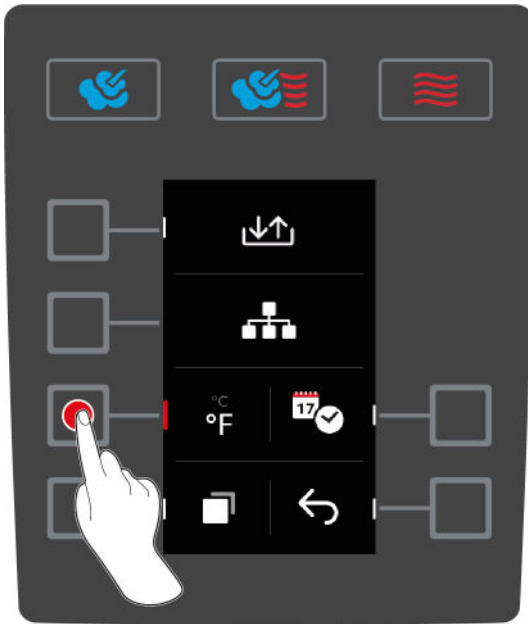

1. Press the button on the start screen: ☰
2. Press the button ⚙️
3. Press the button and select the temperature unit °C or °F.

9.3 Set date and time

You can change the following settings:

- Date in DDMMYYYY format
- Time in HH:MM format
- Real time format in 12-hour format or 24-hour format

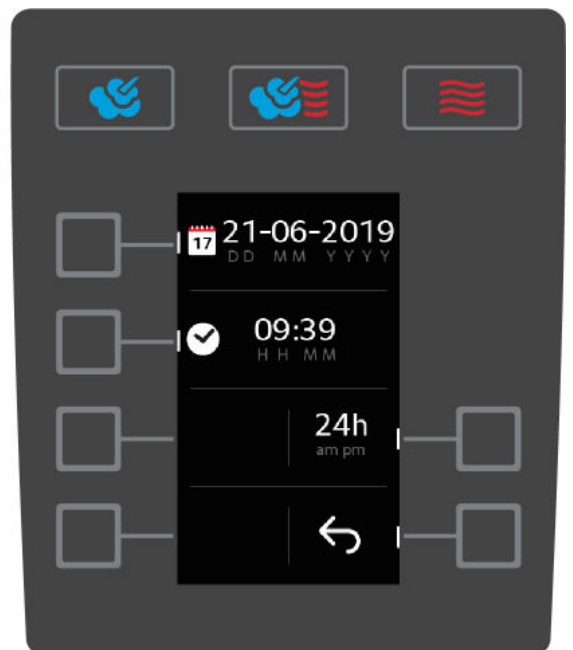
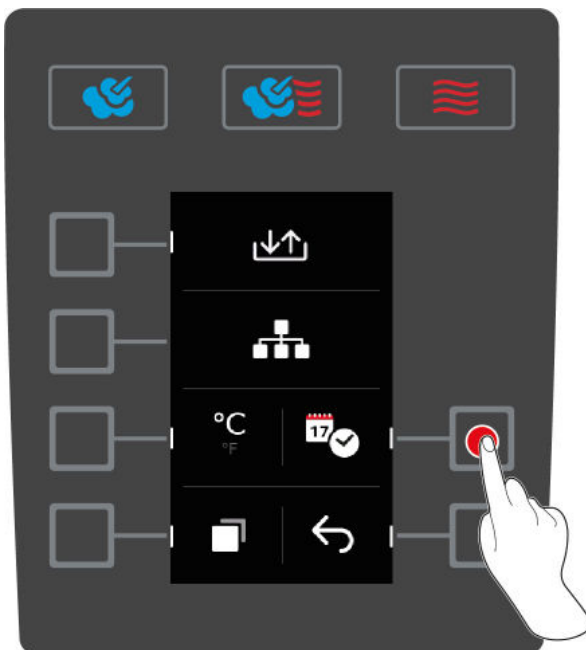

1. Press the button on the start screen: ☰
2. Press the button ⚙️
3. Press the button 📅 (17)

Edit date

1. Press the button 
 - > The **DD** value will start flashing.
2. Turn the central dial and select the desired day.
3. Press the central dial to confirm your setting.
4. Repeat the step until you have edited the month and year entries.

Edit time

1. Press the button 
 - > The **HH** value will start flashing.
2. Turn the central dial and select the desired hour.
3. Press the central dial to confirm your setting.
4. Repeat the steps and set the minutes.



Change real time format

1. Press the button 
 - > The display will switch to the 12-hour format.

9.4 Switch keyboard

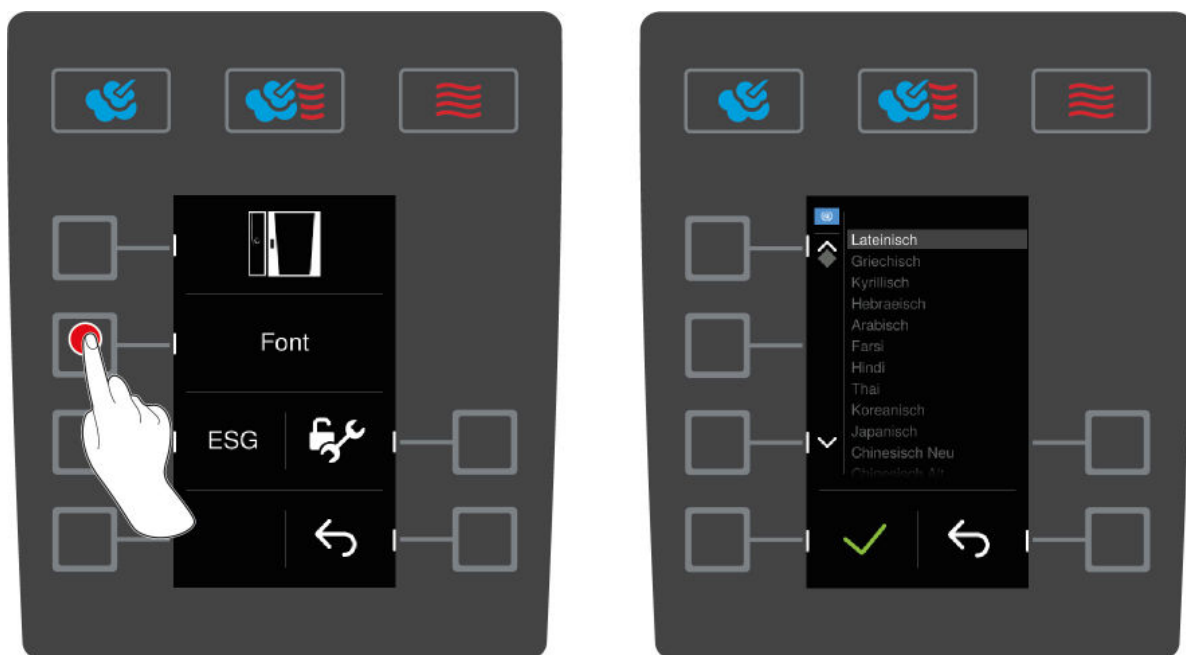
Here you can set which character set should be selected when creating a new programme.



1. Press the button on the start screen: 
2. Press the button 
3. Press the button 
4. Press the button **Font**
 - > A list of available character sets will be displayed.
5. Turn the central dial and select the desired character set.
6. Press the central dial to confirm your setting.

10 Kitchen management

10.1 Hygiene management

10.1.1 Logged HACCP data

The following HACCP data is logged for each batch:

- Batch number
- Unit model
- Serial number
- Software version
- Date and time
- Cleaning programme
- Cabinet temperature
- Set core temperature
- Measured core temperature
- Time (hh:mm:ss)
- Temperature unit
- Energy optimising system connection
- 50% energy
- Opening / closing the cooking cabinet door
- Change of mode
- Automatic cleaning

10.1.2 Download HACCP data

HACCP data will be stored in the unit for 28 days. During this time, you can download the data.

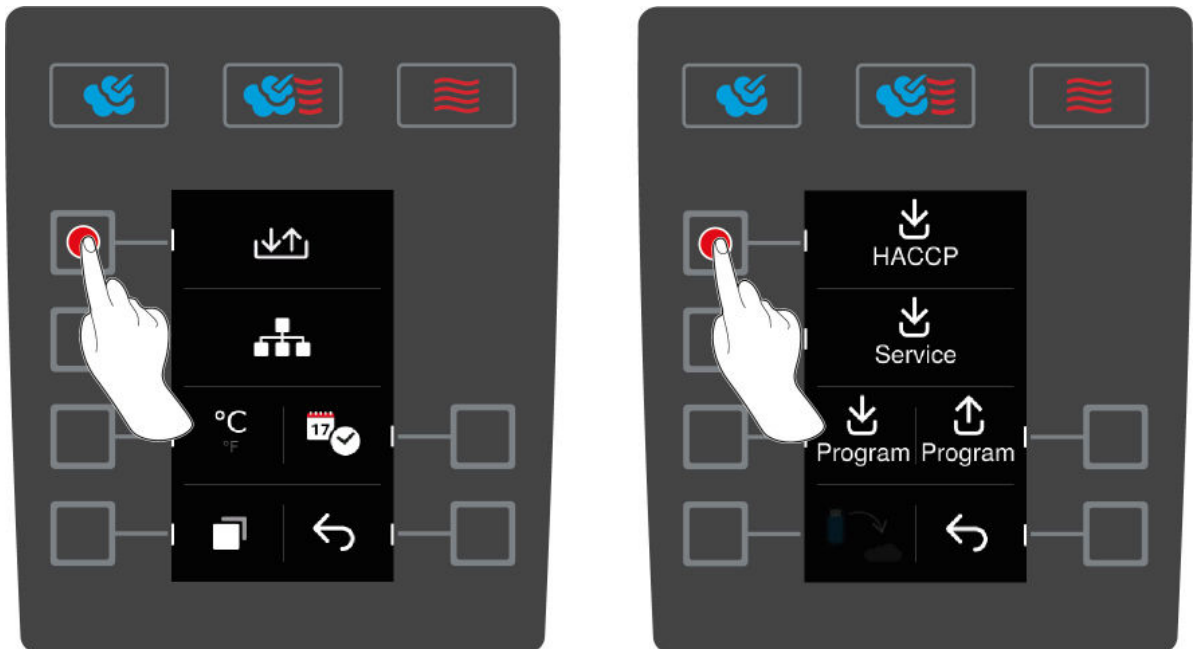

✓ You have connected a USB flash drive with the unit.

1. Press the button on the start screen:
2. Press the button
3. Press the button

4. Press the button HACCP

>> The HACCP data will be downloaded as a .txt file. You can open the file in word processing or spreadsheet programs.

10.2 Connected units to a network

If you want to connect your units with ConnectedCooking, your units must be integrated into a network and equipped with either the optional Ethernet module or the optional WiFi module.

10.3 ConnectedCooking (optional)

If you want to connect your iCombi Classic with ConnectedCooking, your unit must be equipped with the optional WLAN module or Ethernet module.

11 Automatic cleaning

Your iCombi Pro is equipped with an automatic cleaning system. Select the cleaning program, place the displayed number of Active Green tabs and care tabs and the unit will clean itself. At the same time, the integrated care system keeps the steam generator free of scale. This gives you a hygienically clean and optimally maintained unit at all times.

11.1 General safety instructions

- For the automatic clean function, only use the Active Green cleaner tablets and care tabs recommended by the manufacturer.

This will prevent scalding and burns:

- Let the unit and all function parts cool down before you start the automatic clean.

This will prevent chemical burns:

- The care products can cause severe chemical burns on the skin and serious damage to the eyes. Wear tight-fitting protective glasses and chemical-safe protective gloves while cleaning the unit.
- Keep the cooking cabinet door closed during the automatic clean. Corrosive cleaning agents and hot steam may otherwise escape. If you open the cooking cabinet door during the automatic clean, a warning signal will sound.
- Do not leave the core probe hanging out of the unit during the automatic clean. The cooking cabinet door gasket could be damaged and corrosive cleaning agents may escape.
- Do not clean externally attachable core probes with the automatic clean function.
- Remove all care products and residues of care products before heating up the unit and cooking food in it.

If you come in contact with care products, proceed as follows:

- If you touch care products without chemical-safe protective gloves or other skin areas come in contact with Active Green cleaner tablets, rinse the skin area with running water for 10 minutes.
- If a care product gets into your eyes, rinse your eyes with running water for 15 minutes. Remove any contact lenses.
- If you swallow a care product, rinse out your mouth with water and immediately drink half a litre of water. Do not provoke vomiting.
- Call the emergency poison helpline or a doctor.

11.2 Cleaning programmes

The following cleaning programmes are available:



heavy



medium

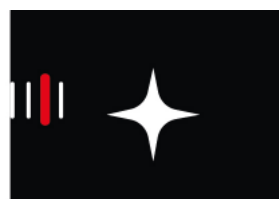

light





Rinse without tabs

Cleaning programme	Description	Care agents required
light	Suitable for removing light dirt and scale resulting from use of the unit at up to 200 °C.	<ul style="list-style-type: none"> ▪ Active Green cleaner tablets ▪ care tabs
medium	Suitable for removing dirt and scale resulting from cooking processes including grilling or roasting.	<ul style="list-style-type: none"> ▪ Active Green cleaner tablets ▪ care tabs
heavy	Suitable for removing heavy dirt and scale resulting from cooking processes including grilling or roasting.	<ul style="list-style-type: none"> ▪ Active Green cleaner tablets ▪ care tabs
Rinse without tabs	Suitable for rinsing the cooking cabinet with warm water.	–

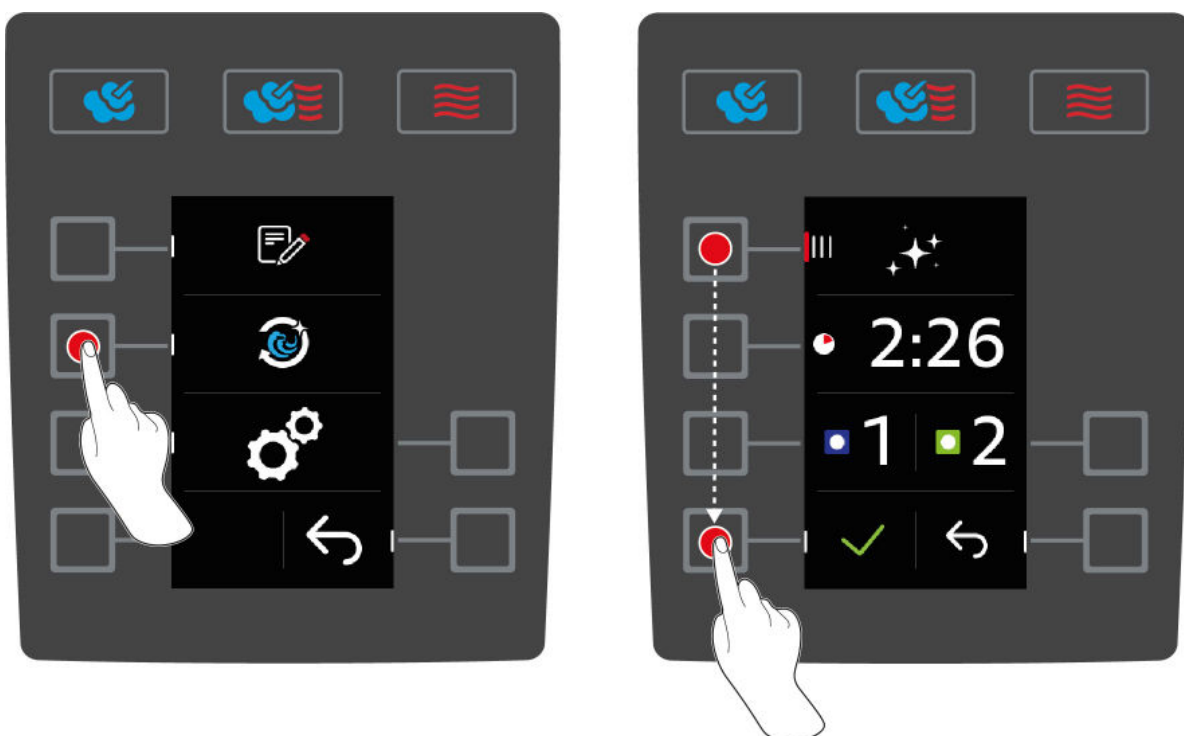
11.3 Start automatic clean



- ✓ The hinging racks are correctly placed in the cooking cabinet.
- 1. Press the button on the start screen: 
- 2. Press the button 
 - > If the cooking cabinet temperature is above 50 °C, this message is displayed: **Cooking cabinet too hot**
- 3. Start the cool down function to reduce the cooking cabinet temperature. Click here for more information: [Functions](#)
- 4. Press the button 
- 5. Turn the central dial and select the desired cleaning program [► 44].
- 6. Open the cabinet door.
- 7. Remove all containers and trays from the cooking cabinet.



8. **⚠ WARNING! Danger of chemical burns! Wear a face mask and chemical-safe gloves for reliable protection when handling Active Green cleaner tabs and care tabs.** Unpack the displayed number of Active Green cleaner tabs and place them in the drain sieve of the cooking cabinet.
 9. Unpack the displayed number of care tab packages and place them in the care drawer.
 10. Close the cooking cabinet door.
 11. To confirm the action, press the button: ✓
- >> The automatic clean starts.
- >> Once the automatic clean is completed, an acoustic signal will sound.



TIPS

- If foam forms in the cooking cabinet during the automatic clean although you used the recommended number of Active Green cleaner tablets, reduce the number of tabs in the next automatic clean. If foam still forms, contact your RATIONAL Service Partner.
- You can light the cooking cabinet with the LED strip during the clean. To do this, press this button: 💡

11.4 Abort automatic clean

You can abort all automatic cleaning programmes 30 seconds after you start them. If the automatic clean has started, you can no longer abort it.

1. Press and hold the button until the status bar is completely displayed: ✗
 - > You will be asked to open the cooking chamber door and remove the Active Green cleaner tabs.
 2. Open the cabinet door.
 3. **⚠ WARNING! Danger of chemical burns! Wear tight-fitting protective glasses and chemical-safe protective gloves for reliable protection when handling Active Green cleaner tablets.** Remove the Active Green cleaner tablets from the cooking cabinet and dispose of them.
 4. Close the cooking cabinet door.
 - > You will be asked to rinse the cooking chamber with the hand shower.
 5. Rinse the cooking chamber using the hand shower.
 6. Close the cooking cabinet door.
- >> The overview of the cleaning programmes is displayed.



TIP

If there is a power outage during the automatic clean, the automatic clean will be interrupted. When the power supply is restored, the automatic clean will continue.

12 Care

WARNING

Fat or food residues in the cooking cabinet

If you do not clean the cooking cabinet sufficiently, there is a risk of fire from fat and food residues.

1. Clean the unit daily.
2. In the event of fire, leave the cooking cabinet door closed. This will remove the oxygen from the fire. Turn off the unit. If the fire has spread, use a fire extinguisher that is suitable to extinguish the fire. Never use a water or foam extinguisher to extinguish the fire.

12.1 General safety instructions

This will prevent scalding and burns:

- Let the unit and all function parts cool down before you perform any cleaning.

This will prevent material damage, injury or fatal accidents:

- Clean your unit daily even if you only use the manual steam mode.
- Do not clean the accessories/trays inside the unit when using automatic clean.

12.2 Care intervals

Care interval	Function parts
Daily	<ul style="list-style-type: none"> ▪ Cooking cabinet ▪ Press-fit door gasket ▪ Cooking cabinet door ▪ Drip tray and drain channel ▪ Core probes ▪ Accessories ▪ Hand shower
Weekly	<ul style="list-style-type: none"> ▪ Unit exterior ▪ LED cover ▪ Control panel ▪ Plastic parts

The functional parts must be cleaned according to the care interval, but can be cleaned more frequently if required.

12.3 Care products

Suitable care products

- Clean the following function parts with lukewarm water, a mild cleaning agent and a soft cloth:
 - Unit exterior
 - Cooking cabinet door glass panel
 - LED cover in the cooking cabinet door
 - Press-fit door gasket
- Clean accessories with lukewarm water, a mild cleaning agent and a soft cloth.

Unsuitable care products

Do not clean the unit, its functional parts and accessories with the following unsuitable care products:

- Scouring cleaning agents or abrasive cloths

- Substances containing hydrochloric acid, caustic solution, sulphur or other oxygen-requiring substances
- Undiluted alcohol, methanol or solvents such as acetone, benzene, toluene or xylene
- Oven cleaner or grill cleaner
- Steel wool
- High-pressure washer
- Sharp or pointed tools

12.4 Cleaning cooking cabinet door

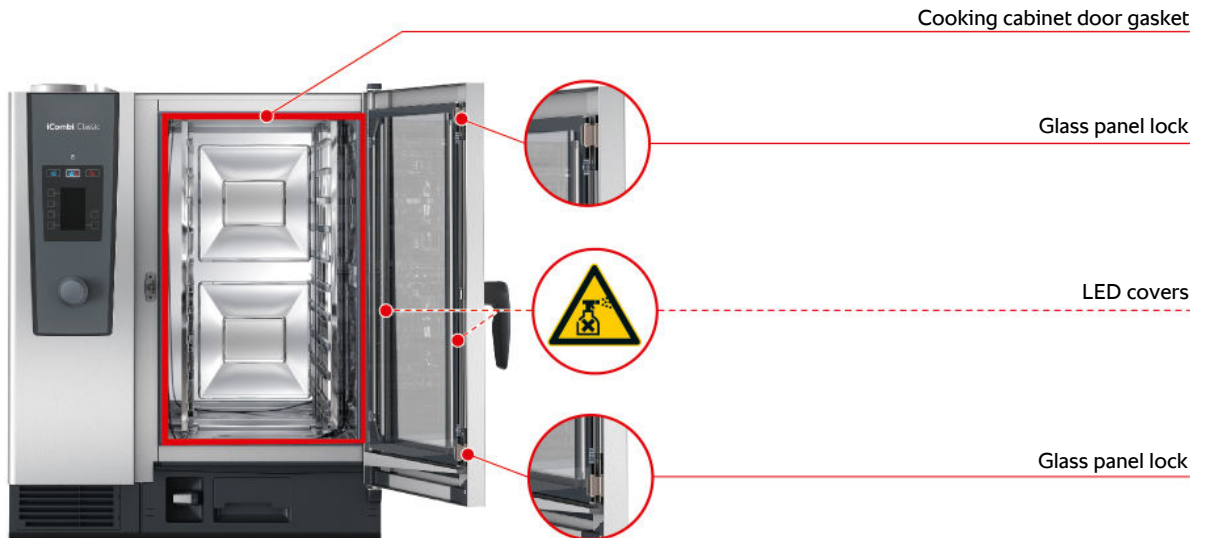

Clean glass panels

1. Open the cooking cabinet door fully until it locks into place.
2. Release the locks on the glass panels by pressing lightly.
3. Swivel the glass panels of the cooking cabinet door open.
4. Clean the glass panels of the cooking cabinet door with lukewarm water, a mild cleaning agent and a soft cloth.
5. Let the glass panels of the cooking cabinet door dry completely.



Clean LED covers

Once you have cleaned the glass panels of the cooking cabinet door, you can also clean the LED covers. Only clean the LED covers with suitable care products [► 47].

The LED cover is between the two glass panels of the cooking cabinet door.

- ✓ The glass panels of the cooking cabinet door are unlocked.
1. Clean the LED cover with lukewarm water, a mild cleaning agent and a soft cloth.
 2. Let the LED cover door dry completely.
 3. Lock the glass panels of the cooking cabinet door back into place.

Clean the cooking cabinet door gasket

If you operate your unit in continuous operation and at high cooking cabinet temperatures above 260 °C and mainly cook fatty and gelatinous food, the cooking cabinet door gasket can quickly become worn. To increase the life of the cooking cabinet door gasket, clean these daily.

- ✓ The cooking cabinet door is open.
1. Clean the cooking cabinet door gasket with lukewarm water, a mild cleaning agent and a soft cloth.
 2. Let the cooking cabinet door gasket dry completely.

12.5 Cleaning the hand shower

1. Pull the hand shower hose out completely and hold it firmly.
2. Clean the hand shower and the hose with a soft sponge.
3. To remove stubborn scale, clean the hand shower and the hose with diluted vinegar.

12.6 Cleaning the drip tray and drain channel

1. Open the cabinet door.
2. To clean the drip tray and drain channel, pour 1 - 2 litres of hot water into the drip tray daily. Do not clean the drip tray with the hand shower.

12.7 Cleaning the air filter



Required tool

- screwdriver

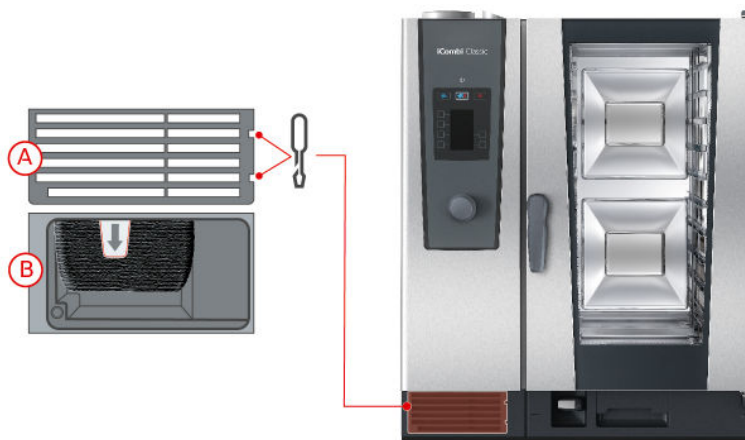

1. Insert the screwdriver in the recesses of the air filter cover (A).
2. Remove the air filter cover.
3. Pull out the air filter (B).
4. Clean the air filter in the dishwasher and then leave it to dry completely.
 - > If the air filter is not clean after washing in the dishwasher, it must be replaced.
5. If the air filter is clean, slide it back into the unit.
6. Reinsert the air filter cover into the unit.

NOTICE

Spraying water may damage the unit if the air filter is not correctly mounted

Protection from water jets from all directions is only assured with a correctly mounted air filter.

1. slide the air filter into the unit until it locks into place.

12.8 Cleaning accessories

1. Let the accessories cool before cleaning.
2. Remove any food residues and layers of fat, starch and protein with a soft cloth.
3. In case of stubborn dirt, soak the accessories in lukewarm water and then remove the dirt with a soft cloth.

13 Inspiration and help

13.1 Telephone help

ChefLine®

We offer a telephone consulting service to answer any questions you have about applications or recipes. Quick, simple, from cook to cook and 365 days a year. Simply call the ChefLine®. You will find the number on the ChefLine® sticker on the cooking cabinet door or at rational-online.com.





RATIONAL Service Partners

Our units are reliable and have a long service life. Should customers ever encounter technical issues; our RATIONAL Service Partners will provide fast, efficient assistance. Guaranteed spare parts supply and a weekend call-out team included. You will find the number at rational-online.com.

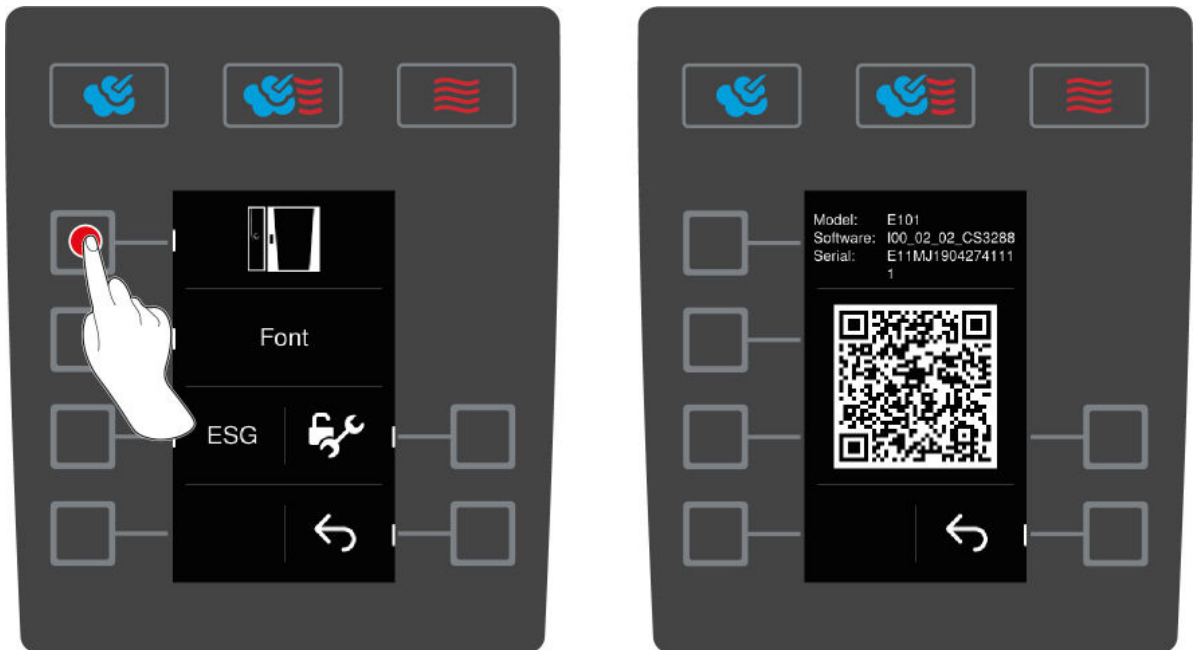
13.2 Retrieving unit data

You can check on the unit which software version is installed and what your unit's serial number is. If you have installed an app on your smartphone which can scan QR codes, you can also load the data onto your smartphone.



1. Press the button on the start screen: 
2. Press the button 
3. Press the button 
4. Press the button 
 - > The following information will be displayed:
 - Unit model
 - Installed software version
 - Unit's serial number

You can scan the QR code shown with your smartphone now to save the information displayed.

13.3 Problem resolution

For all error messages, please contact your RATIONAL Service Partner [► 50]. Always have the serial number of your unit ready. You can find the serial number on the model plate.

13.3.1 Error messages heating steam generator

Error report	Cause	Cooking possible
Service (E) 10 SC-automatic failed	The SC mechanism is faulty.	Yes
Service (E) 11 Water supply steam generator failed	The steam generator's water inlet is faulty.	Yes
Service (E) 12 Water volume measurement failed	The measurement of the water quantity is incorrect.	Yes
Service (E) 13 Water detection failed	The water level in the steam generator is not recognised correctly.	Only the convection mode is available at the moment.
Service (E) 20.8 Steam generator sensor failed	The temperature probe is defective.	Only the convection mode is available at the moment.
Service (E) 28.4 Cooking cabinet too hot	The temperature limit of the cooking cabinet has been exceeded.	Only the convection mode is available at the moment.
Service (E) 42.1 Solenoid valve failed	The water supply is faulty.	Only the convection mode is available at the moment.
Service (E) 43.1 Solenoid valve failed	The internal water supply is not closing.	Only the convection mode is available at the moment.
Service (E) 46.1 Pump failed	The water supply is faulty.	Yes
Service (E) 46.2 Pump failed	The water supply is faulty.	Yes

13.3.2 Error messages for gas units

If your unit is connected to the gas supply, the following additional error message could appear. For all error messages, please contact your RATIONAL Service Partner [► 50]. Always have the serial number of your unit ready.

Error report	Cause	Cooking possible
Service (E) 32.1 Check gas supply	The gas burner is faulty. Close the shut-off valve on the gas line.	No
Service (E) 32.2 Check gas supply	The gas burner is faulty. Close the shut-off valve on the gas line.	No
Service (E) 32.3 Check gas supply	The gas burner is faulty. Close the shut-off valve on the gas line.	No
Service (E) 33.1 Gas burner failed close gas supply	The gas burner is faulty. Close the shut-off valve on the gas line.	No
Service (E) 33.2 Gas burner failed close gas supply	The gas burner is faulty. Close the shut-off valve on the gas line.	No
Service (E) 33.3 Gas burner failed close gas supply	The gas burner is faulty. Close the shut-off valve on the gas line.	No
Service (E) 34.32	The internal data communication is faulty.	Yes

Error report	Cause	Cooking possible
Data communication failed		
Service (E) 60 Gas system failed	The initialisation of the ignition box is defective. Switch the unit off and on again. If the error is still displayed, call your Service Partner.	–

13.3.3 Error messages heating hot air

Error report	Cause	Cooking possible
Service (E) 20.1 Cabinet sensor failed	The temperature probe is defective.	No
Service (E) 28.1 Steam generator too hot	The temperature limit of the steam generator has been exceeded.	No
Service (E) 28.2 Cooking cabinet too hot	The temperature limit of the cooking cabinet has been exceeded.	No
Service (E) 34.1 Data communication failed	The internal data communication is faulty.	No
Service (E) 34.2 Data communication failed	The internal data communication is faulty.	No
Service (E) 34.4 Data communication failed	The internal data communication is faulty.	No
Service (E) 42.3 Solenoid valve failed	The water supply is faulty.	The steam injection is not available.
Service (E) 42.6 Solenoid valve failed	The water supply is faulty.	Yes
Service (E) 43.3 Solenoid valve failed	The internal water supply is not closing.	Only the convection mode is available at the moment.

13.3.4 Error messages moisture

Error report	Cause	Cooking possible
Service (E) 20.2 Control sensor failed	The temperature probe is defective.	Yes
Service (E) 20.4 Humidity sensor failed	The temperature probe is defective.	Yes
Service (E) 30 Humidity control failed	The humidity measurement is incorrect.	Yes
Service (E) 36 Humidity control failed	The differential pressure sensor is defective.	Yes
Service (E) 37 Humidity control failed	The differential pressure sensor is defective.	Yes
Service (E) 42.2 Solenoid valve failed	The water supply is faulty.	Yes
Service (E) 43.2 Solenoid valve failed	The internal water supply is not closing.	Only the convection mode is available at the moment.

13.3.5 Error messages CleanJet

Error report	Cause	Cooking possible
Service (E) 25 Water volume cleanjet too low	The water quantity required by the iCareSystem is too low.	–
Service (E) 26 Drain valve does not open	The ball valve cannot find the open position.	No
Service (E) 27 Drain valve does not close	The ball valve cannot find the closed position.	No
Service (E) 34.8 Data communication failed	The automatic clean does not work.	Yes
Service (E) 43.6 Solenoid valve failed	The internal water supply is not closing.	Only the convection mode is available at the moment.
Service (E) 47.1 Pump failed	The waste water pump is defective.	Yes
Service (E) 47.2 Pump failed	The waste water pump is defective.	Yes
Service (E) 110 Cleanjet failed	An error occurred in the SC pump during the automatic clean.	No
Service (E) 120 Cleanjet failed	An error occurred in the water level recognition during the automatic clean.	No

13.3.6 Error messages Care

Error report	Cause	Cooking possible
Service (E) 42.4 Solenoid valve failed	The water supply is faulty.	Yes
Service (E) 43.4 Solenoid valve failed	The internal water supply is not closing.	Only the convection mode is available at the moment.
Service (E) 49.1 Pump failed	The water supply is faulty.	Yes
Service (E) 49.2 Pump failed	The water supply is faulty.	Yes

13.3.7 Notification centre

Error report	Cause	Cooking possible
Service (E) 17 Unit data failed	The unit model is incorrect.	No
Service (E) 29 Electric compartment too hot	The board temperature is too high.	No
Service (E) 31.1 Core temperature sensor failed	The core probe in the cooking cabinet is defective.	Yes, but you cannot use the core probe.
Service (E) 31.2 Core temperature sensor on emergency run	The core probe in the cooking cabinet is defective.	Yes, but you cannot use the core probe.
Service (E) 34.16	The internal data communication is faulty.	Yes

Error report	Cause	Cooking possible
Data communication failed		
Service (E) 34.64 Data communication failed	The internal data communication is faulty.	Yes
Service (E) 34.400 Data communication failed	The internal data communication is faulty.	Yes
Service (E) 41	The steam injection nozzle or the steam injection pipe has scale.	The steam injection is not available.
Service (E) 50 Initialise timer	The real time clock on the CPU is not initialised. Set the date and time.	Yes
Service (E) 51 Battery failed	The battery is defective.	Yes
Service (E) 52.1 Cabinet light failed	The cooking cabinet lighting is not working correctly.	Yes
Service (E) 52.2 Cabinet light failed	The cooking cabinet lighting is not working correctly.	Yes
Service (E) 72 The safety temperature limiter has initialised	The activation temperature of a temperature probe has been exceeded.	No

13.3.8 Error messages when operating the UltraVent

The following error messages may appear when you operate your unit with an UltraVent. For all error messages, please contact your RATIONAL Service Partner [► 50]. Always have the serial number of your unit ready.

Error report	Cause
Service (E) 35	The unit hood is not recognised.
Service (E) 35.1	The unit hood motor is defective.
Service (E) 35.2	The unit hood filter is not recognised.
Service (E) 35.3	The thermal element control is faulty.
Service (E) 35.4	The motor protection thermal element is faulty.
Service (E) 35.5	The UltraVent filter is dirty.
Service (E) 35.6	The UltraVent filter is dirty.
Service (E) 35.7	The UltraVent filter is not inserted.

14 Maintenance

You can perform the following maintenance work yourself:

- Replacing air filter [▶ 55]
- Replacing the cooking cabinet door gasket [▶ 56]

For the following maintenance work, contact your RATIONAL Service Partner:

- Replacing LED cover

14.1 Replacing air filter



Required tool

- screwdriver



✓ A message will be displayed that the air filter needs to be replaced.

1. Insert the screwdriver in the recesses of the air filter cover.
2. Remove the air filter cover.
3. Pull out the air filter.
4. Slide the new air filter into the unit until it locks into place.
5. Reinsert the air filter cover into the unit.

NOTICE

Spraying water may damage the unit if the air filter is not correctly mounted

Protection from water jets from all directions is only assured with a correctly mounted air filter.

1. slide the air filter into the unit until it locks into place.

14.2 Replacing the cooking cabinet door gasket







1. Open the cabinet door.
2. Pull the cooking cabinet door gasket out from the groove and dispose of it.
3. Moisten the retaining lips of the new gasket with soapy water.
4. First press the corners of the gasket into the corners of the groove.
5. Then press the rest of the gasket into the groove.

15 Transport

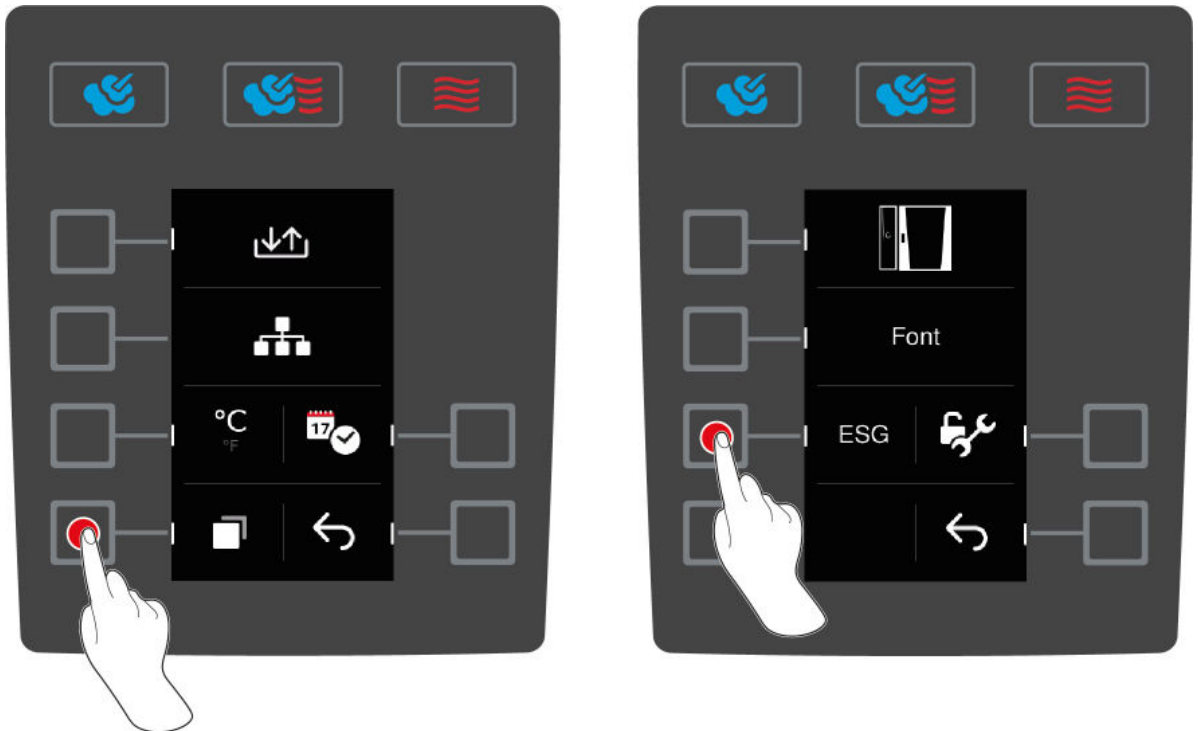
15.1 Empty steam generator

Before transporting the unit, you must empty the steam generator.



1. Disconnect the unit from the water supply.
 2. Press the button on the start screen: 
 3. Press the button 
 4. Press the button 
 5. Press the button **ESG**
- >> The steam generator is emptied.

15.2 Transport unit

WARNING

The castors can be damaged if the unit or the Combi-Duo is moved with the parking brakes applied

If the castors are damaged, the unit or the Combi-Duo could tip over and seriously injure you.

1. Release the parking brakes on the castors before you transport or move the unit or the Combi-Duo.

WARNING

The castors can be damaged if the alignment of the castors is changed with the parking brakes applied

If the castors are damaged, the unit or the Combi-Duo could tip over and seriously injure you.

1. If the castors protrude from under the unit or the stand and you wish to change the alignment of the castors, first release the parking brakes and then turn the castors.
2. Do not kick against the castors.

⚠ CAUTION

Units could tip over when transported over thresholds or inclinations

When moving units over thresholds or inclinations, the unit could tip over and injure you.

1. Carefully move units over thresholds and inclinations.

⚠ CAUTION

Units and Combi-Duos on castors can tip over when transported or moved

If your unit is on castors or your Combi-Duo is on a stand with castors and you do not release the parking brakes before you transport or move the unit, the unit or Combi-Duo may tip over and injure you.

1. Release the parking brakes on the castors before you transport or move the unit or the Combi-Duo.
2. Apply the parking brakes again after transport.

You can move units that are on mobile stands or castors.

✓ The steam generator has been emptied [► 57].

1. Before you transport the unit to another location, you must properly disconnect the unit from the power supply and from the water and waste water pipes.
2. Once you have transported the unit to its new space, you must properly reconnect the unit to the power supply and the water and waste water pipes and apply the parking brakes on the mobile stand or the castors.



3. If you would like to pull the unit forwards slightly when cleaning the kitchen, release the parking brakes of the mobile stand or the castors.
4. Carefully pull the unit forwards.
5. Once you are finished with cleaning the kitchen, carefully slide the unit back into place and apply the parking brakes.

16 Decommissioning and disposal

16.1 Decommissioning

Contact your RATIONAL Service Partner if you would like to decommission the unit.

16.2 Disposal



Old units contain recyclable materials. Dispose of old units in an environmentally sound way using the appropriate disposal systems.

17 Technical data

Please also note the technical data on the model plate. The model plate is on the left next to the control panel.

17.1 Units with an electrical connection

	Value
Weight (without packaging)Model 6-1/1	147 kg
Weight (without packaging)Model 6-2/1	93 kg
Weight (without packaging)Model 10-1/1	118 kg
Weight (without packaging)Model 10-2/1	182 kg
Protection class	IPX5
Airborne sound emission	≤70 dBA
Environmental conditions	10 – 40 °C
Frequency and max. transmission power WLAN	2.4 GHz/40.7 mW

17.2 Units with a gas connection

	Value
Weight (without packaging)Model 6-1/1	104 kg
Weight (without packaging)Model 6-2/1	160 kg
Weight (without packaging)Model 10-1/1	134 kg
Weight (without packaging)Model 10-2/1	196 kg
Protection class	IPX5
Airborne sound emission	≤70 dBA
Environmental conditions	10 – 40 °C
Frequency and max. transmission power WLAN	2.4 GHz/40.7 mW

17.3 Models and version names

The model names and the version on the model plate are different. Please refer to the classification in this table.

Model	Version name
LMxxxB	iCombi Classic 6-1/1
LMxxxC	iCombi Classic 6-2/1
LMxxxD	iCombi Classic 10-1/1
LMxxxE	iCombi Classic 10-2/1

17.4 Conformity

17.4.1 Units with an electrical connection

This unit meets the following EU directives:

- Directive 2014/53/EU on the harmonisation of the laws of the Member States relating to the making available on the market of radio equipment
- Directive 2006/42/EU on machinery
- Directive 2014/30/EU on the harmonisation of the laws of the Member States relating to electromagnetic compatibility
- Directive 2011/65/EU Restriction of the use of certain hazardous substances in electrical and electronic equipment, including 2015/863/EU

This unit meets the following European standards:

- EN 60335-1:2012 + A11:2014 + A13:2017
- EN 60335-2-42:2002 + A1:2008 + A11:2012
- EN 61000-3-2:2014; EN 61000-3-3:2013
- EN 55014-1:2006+A1:2009+A2:2011; EN55014-2:2015
- EN 62233:2008
- EN 1717:2000

17.4.2 Units with a gas connection

This unit meets the following EU directives:

- Regulation (EU) 2016/426 on units burning gaseous fuels
- Directive 2014/53/EU on the harmonisation of the laws of the Member States relating to the making available on the market of radio equipment
- Directive 2006/42/EU on machinery
- Directive 2014/30/EU on the harmonisation of the laws of the Member States relating to electromagnetic compatibility
- Directive 2011/65/EU Restriction of the use of certain hazardous substances in electrical and electronic equipment, including 2015/863/EU

This unit meets the following European standards:

- EN 60335-1:2012 + A11:2014 + A13:2017
- EN 60335-2-42:2002 + A1:2008 + A11:2012
- EN 60335-2-102:2016
- EN 61000-3-2:2014; EN 61000-3-3:2013
- EN 55014-1:2006+A1:2009+A2:2011; EN55014-2:2015
- EN 62233:2008
- EN 203-1:2014; EN203-2-2:2006; EN 203-3-:2009
- EN 1672-1:2014
- EN 1717:2000

18 Regulatory Information

USA

This device complies with part 15 of the FCC Rules. Operation is subject to the following two conditions:

- (1) This device may not cause harmful interference, and
- (2) this device must accept any interference received, including interference that may cause undesired operation.

This equipment has been tested and found to comply with the limits for a Class A digital device, pursuant to part 15 of the FCC Rules. These limits are designed to provide reasonable protection against harmful interference when the equipment is operated in a commercial environment. This equipment generates, uses, and can radiate radio frequency energy and, if not installed and used in accordance with the instruction manual, may cause harmful interference to radio communications. Operation of this equipment in a residential area is likely to cause harmful interference in which case the user will be required to correct the interference at his own expense.

FCC ID: 2AUI6-LM2

A

Air filter	
Cleaning	49
Air speed	25

C

Cabinet door	
Clean gasket	48
Clean LED cover	48
Cleaning	48
Cabinet temperature	24
Combination of steam and hot air	27
Convection	28
Finishing	31
Steam	26
Care	
Accessories	49
Care products	
Suitable cleaning agents	47
Unsuitable cleaning agents	47
Central dial	12
Cleaning	48
Clean LED cover	48
Cleaning	
Air filter	49
Cabinet door	48
Cooking cabinet door gasket	48
LED cover	48
Cleaning programmes	
Light	45
Medium	45
Rinse without tabs	45
Strong	45
Continuous operation	24
Cooking cabinet climate	
Combination of steam and hot air	27
Convection	28
Finishing	31
Steam	26
Cooking time	24
Cool-down function	25
Core probes	
Baked goods	19
Fish fillets	19
Inserting into the food	17
Large pieces of meat	18
Remove	19
Small food item	19
Steak	18
Vegetables	19
Whole chicken	18
Whole fish	19
Core temperature	24

G

Gas smell	9
-----------	---

H

Hand shower	19
Spray	19
Heat	25

M

Maintenance	
Replace air filter	55
Replace gasket	56

O

Operating the unit	
Central dial	12
Moves	12

P

Performing maintenance yourself	55
Program manual preheating	35
Programme cooking step	35
Programming mode	
Add cooking step	37
Delete cooking step	37
Edit cooking parameter	37

R

Replace air filter	55
Replace gasket	56
Rinse without tabs	45

S

Sous-vide cooking	
Cook and chill	30
Fields of use	30
Room service	30
Special diets and clean eating	30
Start programme	36
Switch off the unit	12
Switch on the unit	12

RATIONAL UK Limited

Siegfried-Meister-Straße 1

86899 Landsberg am Lech

Tel. +49 (0)8191 3270

Fax +49 (0)8191 21735

info@rational-online.com

rational-online.com